



HUNDREDS OF NEW REPLACEMENT PARTS FOR THE HEAVY DUTY TRUCK INDUSTRY

EGR COMPONENTS • RESERVOIRS • CAB REPAIR • LIGHTING • ENGINE SENSORS • AND MANY MORE!



TABLE OF CONTENTS



ICON KEY

Throughout this catalog, look for icons that quickly identify parts for:



SCHOOL BUS

These products also fit specific school bus makes



CARDED PRODUCT

These parts come packaged for front-end store displays, just add CD to the end of the part number when ordering

HEAVY DUTY MAKES

3-76

Freightliner	4
International.....	19
Kenworth	32
Mack	43
Peterbilt.....	52
Sterling	61
Volvo.....	65
Western Star.....	73

MEDIUM DUTY MAKES

77-82

GM Isuzu Workhorse	78
Hino	82

SPECIALTY COVERAGE

83-102

Caterpillar.....	84
Cummins.....	86
Detroit Diesel.....	89
Eaton	90
Refuse	91
School Bus, Thomas Bus / Freightliner.....	97
School Bus, International	99

ABS SENSORS

103-110

ABS Sensors.....	104
------------------	-----

PART NUMBER INDEX

111-115

FOR COMPLETE PRODUCT DETAILS & ADDITIONAL INFORMATION, VISIT
WWW.DORMANHDSOLUTIONS.COM



Growing the size of the **HEAVY DUTY** Aftermarket

HEAVY DUTY MAKES

Freightliner	4
International.....	19
Kenworth	32
Mack	43
Peterbilt	52
Sterling	61
Volvo.....	65
Western Star.....	73

FREIGHTLINER

ABS Wheel Speed Sensor Bracket – Door Mirror Glass

ABS Wheel Speed Sensor Bracket 924-5209



Make: Freightliner
Applications: Columbia, Columbia 112, Columbia 120, FLD 112, FLD 120, FLD 132, FLD120 SD 1996 - 2005
Position:
Notes:
OE Number: 1013536000, 3527646C1, 3527646C2, 4C4Z-2A155-AA

Axle Vent 924-5213



Make: Freightliner
Applications: Fits Rockwell and Meritor Differentials 1981-2014
Position: Rear
Notes:
OE Number: KIT2902

Bumper Extension 242-5204



Make: Freightliner
Applications: Columbia, Columbia 112, Columbia 120 2000 - 2015
Position: Front Left Outer
Notes: Gray, Paintable
OE Number: 21-26021-000, 2126021004

Bumper Trim 242-5205



Make: Freightliner
Applications: Cascadia, Cascadia 113, Cascadia 125 2008 - 2015
Position: Front Center
Notes: Gray, Paintable
OE Number: 2128443010, 2128446000

Clutch Starter Safety Switch 901-5207



Make: Freightliner
Applications: Cascadia 2007 - 2016
Position:
Notes:
OE Number: 3923668C95, 5001857052, 8235-59650010092, 9650010092, 59650010092, 5965-001-009-2, TDA 5965 001 009 2, TDA59650010092

Dashboard Air Vent 216-5202



Make: Freightliner
Applications: Classic, Classic XL 1995 - 2005
Position: Right
Notes: Black
OE Number: 22-33741-000

Dashboard Air Vent 216-5203



Make: Freightliner
Applications: Century, Century Class, Columbia, Coronado 2000 - 2011
Position: Center, Left, Right
Notes: Gray
OE Number: A22-61254-000

Diesel Emissions Fluid Filler Cap 904-5201



Make: Freightliner
Applications: 108SD, 1145D, Argosy, Business Class M2, Cascadia, Cascadia 113, Cascadia 125, Century, Century Class, Century CST120, Classic, Columbia, Columbia 120, Coronado, Coronado 122, Coronado 132, FLD 120, FLD 132, FLD120 SD, M2 106, M2 112 2010 - 2012
Position:
Notes:
OE Number: 04-27757-000

Diesel Particulate Filter Clamp 674-9000



Make: Freightliner
Applications: Cummins ISX 11.9, ISX 11.9G, ISX 15.0, ISX, ISX-385 ST, ISX-400, ISX-425, ISX-450 2007 - 2015
Position:
Notes: w/2007 & 2010 EPA Standards
OE Number: 21445455

Door Check 924-5215



Make: Freightliner
Applications: M2 106, M2 112 2008 - 2012
Position:
Notes:
OE Number: A18-43533-000

Door Mirror Drive Motor 924-5204



Make: Freightliner
Applications: Cascadia 2008 - 2009
Position: Left
Notes:
OE Number: 28569

Door Mirror Glass 955-5201



Make: Freightliner
Applications: Columbia, Columbia 112, Columbia 120, M2 106, M2 112 2002 - 2011
Position: Left, Right
Notes: w/Two Piece Power Mirror Assembly, Heated Spot Mirror
OE Number: A2259713001

FREIGHTLINER

Door Mirror Glass – Door Window Switch

Door Mirror Glass 955-5208



Make:	Freightliner
Applications:	Argosy, Century Class, Century CST120, Columbia, Columbia 112, Columbia 120, Coronado 132 2004 - 2011
Position:	Left, Right
Notes:	w/One Piece Power Mirror Assembly, Full Length Heated Mirror
OE Number:	TL28531

Door Mirror Switch 901-5201



Make:	Freightliner
Applications:	Century 2003 - 2009
Position:	Front Left
Notes:	
OE Number:	34103PF

Door Seal 750-5203



Make:	Freightliner
Applications:	Business Class M2, M2, M2 100, M2 106, M2 112 2002 - 2015
Position:	Left Outer
Notes:	Primary Seal
OE Number:	A1845220000

Door Seal 750-5206



Make:	Freightliner
Applications:	Business Class M2, M2, M2 100, M2 106, M2 112 2002 - 2015
Position:	Right Outer
Notes:	Primary Seal
OE Number:	A1845220001

Door Seal 750-5207



Make:	Freightliner
Applications:	Business Class M2, M2, M2 100, M2 106, M2 112 2004 - 2015
Position:	Inner
Notes:	Secondary Seal
OE Number:	1848637000, 1863922000

Door Seal 750-5208



Make:	Freightliner
Applications:	Business Class M2, M2, M2 100, M2 106, M2 112 2002 - 2015
Position:	Left, Right
Notes:	Rain Gutter Seal
OE Number:	1845727001, 1863286000

Door Seal 750-5209

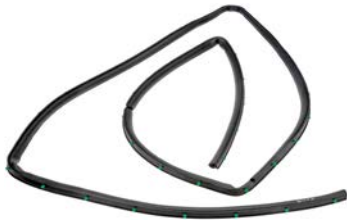

Make:	Freightliner
Applications:	Cascadia, Cascadia 113, Cascadia 125 2012 - 2016
Position:	Right
Notes:	Primary Seal
OE Number:	A18-64636-001

Door Seal 750-5211



Make:	Freightliner
Applications:	Cascadia, Cascadia 113, Cascadia 125 2008 - 2011
Position:	Left
Notes:	Primary Seal
OE Number:	A1859743000

Door Seal 750-5213



Make:	Freightliner
Applications:	Columbia, Columbia 112, Columbia 120 2003 - 2015
Position:	Left, Right
Notes:	Primary Seal
OE Number:	A18-44466-000

Door Seal 750-5214



Make:	Freightliner
Applications:	Columbia, Columbia 112, Columbia 120 2013 - 2015
Position:	Left
Notes:	Secondary Seal
OE Number:	A18-41364-002, A1841364004, A18-41364-006

Door Seal 750-5215



Make:	Freightliner
Applications:	Columbia, Columbia 112, Columbia 120 2013 - 2015
Position:	Right
Notes:	Secondary Seal
OE Number:	A18-41364-003, A1841364005, A18-41364-007

Door Window Switch 901-5204



Make:	Freightliner
Applications:	Columbia 2003 - 2010
Position:	Left
Notes:	1 Button, Express Down
OE Number:	A06-30769-008

FREIGHTLINER

Door Window Switch – EGR Valve

Door Window Switch	901-5205 
	
Make:	Freightliner
Applications:	Columbia 2003 - 2010
Position:	Right
Notes:	1 Button
OE Number:	A06-30769-027

EGR Cooler	904-5035
	
Make:	Freightliner
Applications:	Cummins ISX 15 2003 - 2007
Position:	
Notes:	Includes all gaskets and hardware
OE Number:	2869133, 2878071, 2881783, 2881783NX, 3682806, 3682986, 3683069, 3683253, 3683435, 4089166, 4089436, 4952490, 4956008, 4956008NX

EGR Cooler	904-5036
	
Make:	Freightliner
Applications:	Cummins Gen 1 ISM 10.8, ISM 10.8, 112 SubModel, ISM 10.8, WX42 SubModel, ISM 10.8, WX64 SubModel 2003 - 2007
Position:	
Notes:	Includes all gaskets and hardware
OE Number:	3102803, 4089380, 4089380NX

EGR Cooler Gasket Kit	904-5007
	
Make:	Freightliner
Applications:	Cummins Gen 1 ISX 15.0, ISX 15.0, CL700 SubModel, ISX-400, ISX-450, ISX-475, ISX-500, ISX-565, ISX-600 2003 - 2007
Position:	
Notes:	Includes all gaskets and hardware
OE Number:	4309434NX

EGR Cooler Gasket Kit	904-5008
	
Make:	Freightliner
Applications:	ISX 15.0, ISX-400, ISX-450, ISX-475, ISX-500, ISX-565, ISX-600 2007 - 2010
Position:	
Notes:	Generation 2, Includes all gaskets and hardware
OE Number:	2881747, 2881747NX, 2881784, 2881784NX, 3684448, 4309248, 4309248NX, 4309398, 4309398NX, 4955467, 4955926

EGR Cooler Gasket Kit	904-5009
	
Make:	Freightliner
Applications:	Cummins ISX 11.9, ISX 15 2010 - 2011
Position:	
Notes:	Includes all gaskets and hardware
OE Number:	4309491NX

EGR Cooler Gasket Kit	904-5010
	
Make:	Freightliner
Applications:	Cummins ISM 2002 - 2006
Position:	
Notes:	Generation 1, Includes all gaskets and hardware
OE Number:	4089380NX

EGR Cooler Gasket Kit 	904-5012
	
Make:	Freightliner
Applications:	ISB 5.9, ISB E-175, ISB E-190, ISB E-195, ISB E-210, ISB 2002 - 2006
Position:	
Notes:	Includes all gaskets and hardware
OE Number:	4089256NX

EGR Cooler Gasket Kit 	904-5013
	
Make:	Freightliner
Applications:	ISB 200, ISB 5.9, ISB, ISB6.7-200, ISB6.7-220, ISB6.7-240, ISB6.7-260, ISB6.7-280 2007 - 2010
Position:	
Notes:	Includes all gaskets and hardware
OE Number:	4955518NX

EGR Pressure Feedback Sensor 	904-5052
	
Make:	Freightliner
Applications:	Cummins ISB 2006 - 2014
Position:	
Notes:	2007 and 2010 EPA Emission Standard
OE Number:	4921746, 4928594

EGR Valve	904-5001
	
Make:	Freightliner
Applications:	Cummins ISX 2003 - 2007
Position:	
Notes:	Fits Engines Manufactured From 09/31/2002, Generation 1, Includes all gaskets and mounting hardware
OE Number:	3104874, 3682805, 3682954, 3682974, 3683305, 3683446, 3684004, 4955422, 4955422NX, 4955422RX, 4955422-RX

EGR Valve	904-5002
	
Make:	Freightliner
Applications:	Cummins ISM 2003 - 2007
Position:	
Notes:	Fits Engines Manufactured From 09/31/2002, Generation 1, Includes all gaskets and mounting hardware
OE Number:	2102745, 3103361, 3103765, 3103824, 3104875, 4921905, 4955421, 4955421RX, 4955421-RX

EGR Valve 904-5073



Make:	Freightliner
Applications:	Mercedes-Benz MBE4000 engines 2003 - 2006
Position:	
Notes:	2003 EPA Standard, Includes all gaskets and mounting hardware
OE Number:	RA4601420419

Engine Camshaft Position Sensor 904-7017



Make:	Freightliner
Applications:	Caterpillar C15 engines 2004 - 2005
Position:	Center Upper
Notes:	
OE Number:	2016617

Engine Camshaft Position Sensor 904-7129



Make:	Freightliner
Applications:	Century Class, FC70, FC80, FL50, FL60, FL70, FL80, MT45, MT55, with Cummins ISB engines 1998 - 2001
Position:	
Notes:	
OE Number:	4921597

Engine Coolant Level Sensor 924-5205



Make:	Freightliner
Applications:	Cascadia, Columbia 2007 - 2010
Position:	
Notes:	Fits OE Bottle A05-25263-005, Dorman bottle 603-5203
OE Number:	06-62384-002

Engine Coolant Pipe 936-5201



Make:	Freightliner
Applications:	Argosy, Columbia, with Series 60 Detroit Diesel 1999 - 2010
Position:	Lower
Notes:	Stainless
OE Number:	A05-16380-003

Engine Coolant Pipe 936-5202



Make:	Freightliner
Applications:	Century CST120, Columbia 120 with Caterpillar C15 2001 - 2004
Position:	Lower
Notes:	Stainless
OE Number:	A05-16384-000, A05-16384-001

Engine Coolant Pipe 936-5203



Make:	Freightliner
Applications:	Century, Century Class, Century CST112, Century CST120, Columbia, Columbia 120, with Detroit Diesel 2005 - 2007
Position:	Upper
Notes:	Stainless
OE Number:	523103000

Engine Coolant Reservoir 603-5201



Make:	Freightliner
Applications:	Century, Century Class, Century CST112, Century CST120, Columbia, Columbia 112, Columbia 120 2001 - 2007
Position:	
Notes:	Includes caps, pump, and level sensors (where applicable)
OE Number:	05-20529-000, 05-23045-000, 05-23045-001

Engine Coolant Reservoir 603-5202



Make:	Freightliner
Applications:	Business Class M2, C2, M2, M2 100, M2 106, M2 112, SAF-T-LINER C2 2005 - 2011
Position:	
Notes:	Includes caps, pump, and level sensors (where applicable)
OE Number:	05-21178-000, 05-23195-000, 05-23195-001, 205-30740-000

Engine Coolant Reservoir 603-5203



Make:	Freightliner
Applications:	Cascadia, Cascadia 113, Cascadia 125, Century, Century Class, Century CST120, Columbia, Columbia 120 2008 - 2014
Position:	
Notes:	Includes caps, pump, and level sensors (where applicable)
OE Number:	A0525263005, A0525263007

Engine Coolant Reservoir 603-5207



Make:	Freightliner
Applications:	Business Class M2, M2 106, M2 112 2012 - 2016
Position:	
Notes:	Includes caps, pump, and level sensors (where applicable)
OE Number:	A0528531000, A0528531001, A0528531002

Engine Coolant Reservoir 603-5209



Make:	Freightliner
Applications:	FLD 2005-2007 Only
Position:	
Notes:	Includes caps, pump, and level sensors (where applicable)
OE Number:	a0523063000

FREIGHTLINER

Engine Coolant Reservoir Cap – Engine Oil Drain Plug

Engine Coolant Reservoir Cap  902-5201 



Make:	Freightliner
Applications:	Century, Classic, Classic XL, Columbia 2004 - 2010
Position:	
Notes:	Surge Cap, 15 PSI
OE Number:	05-20763-000, 05-20763-001

Engine Coolant Reservoir Cap  902-5202 



Make:	Freightliner
Applications:	C2, M2, M2 106, M2 112, SAF-T-LINER C2 2004 - 2011
Position:	
Notes:	20 PSI
OE Number:	05-17223-002

Engine Coolant Reservoir Cap 902-5204



Make:	Freightliner
Applications:	MT35 1996 - 2009
Position:	
Notes:	Radiator
OE Number:	1413161000

Engine Coolant Temperature Sensor 505-5203



Make:	Freightliner
Applications:	FLD 112, FLD 120, FLD 132, FLD120 SD, With Caterpillar electric gauge 1993 - 2010
Position:	
Notes:	
OE Number:	2254800000

Engine Coolant Temperature Sensor 904-7039



Make:	Freightliner
Applications:	Caterpillar 3406 engines 1994 - 1997
Position:	
Notes:	
OE Number:	1022240

Engine Crankshaft Position Sensor 904-7020



Make:	Freightliner
Applications:	Caterpillar 3126BTA6 engines 2002 - 2003
Position:	Rear Left Rearward
Notes:	
OE Number:	1194142, 1693300, 2454630

Engine Crankshaft Position Sensor 904-7021



Make:	Freightliner
Applications:	Caterpillar C11 engines 2004 - 2006
Position:	Rear Left
Notes:	
OE Number:	2016615

Engine Crankshaft Position Sensor 904-7024



Make:	Freightliner
Applications:	Caterpillar C15 engines 2003 - 2004
Position:	Rear
Notes:	
OE Number:	1918303

Engine Crankshaft Position Sensor  904-7123



Make:	Freightliner
Applications:	Cummins ISB 5.9 1998 - 2001
Position:	Front
Notes:	
OE Number:	4921601

Engine Crankshaft Position Sensor 904-7247



Make:	Freightliner
Applications:	Detroit Diesel Series 60 engines 2007 - 2007
Position:	
Notes:	
OE Number:	8929387

Engine Oil Dipstick 917-5201

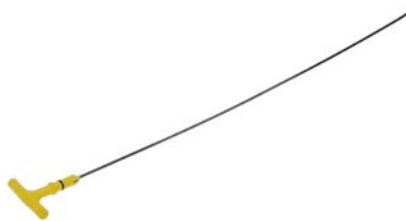



Make:	Freightliner
Applications:	Argosy, Cascadia, Century Class, Classic, Classic XL, Columbia, Coronado with Detroit Diesel Series 60 engines 2008 - 2011
Position:	
Notes:	
OE Number:	23534354

Engine Oil Drain Plug 090-5001 





Make:	Freightliner
Applications:	Caterpillar 3176, C10, C11, C12, C13, 1989 - 2013
Position:	
Notes:	
OE Number:	9X6451

Engine Oil Drain Plug 090-5002 





Make:	Freightliner
Applications:	Cummins ISL, L10 engines 1974 - 2014
Position:	
Notes:	
OE Number:	3055069

Engine Oil Drain Plug 090-5003 



Make:	Freightliner
Applications:	Cummins ISX 11.9, ISX 11.9G, ISX 15.0 1998 - 2015
Position:	
Notes:	
OE Number:	4926565

Engine Oil Drain Plug 090-5004 



Make:	Freightliner
Applications:	Detroit Diesel Series 60 Engines 1987 - 2015
Position:	
Notes:	
OE Number:	23505720

Engine Oil Drain Plug Gasket 095-5001 



Make:	Freightliner
Applications:	Caterpillar 3176, C10, C11, C12, C13 engines 1989 - 2013
Position:	
Notes:	
OE Number:	619458

Engine Oil Drain Plug Gasket 095-5002 



Make:	Freightliner
Applications:	Cummins ISL, L10 Engines 1981 - 2010
Position:	
Notes:	
OE Number:	67946

Engine Oil Drain Plug Gasket 095-5003 



Make:	Freightliner
Applications:	Cummins ISX 11.9, ISX 15.0 1998 - 2015
Position:	
Notes:	
OE Number:	3678606

Engine Oil Pressure Sensor 904-5050



Make:	Freightliner
Applications:	Cummins ISX 11.9, ISX 11.9G, ISX 15.0, ISX 2014 - 2016
Position:	
Notes:	
OE Number:	4921517

Engine Oil Pressure Sensor 904-7012



Make:	Freightliner
Applications:	Caterpillar 3126 engines 1999 - 2000
Position:	
Notes:	
OE Number:	1946726, 2244536

Engine Oil Pressure Sensor 904-7016



Make:	Freightliner
Applications:	Caterpillar C10 engines 1998 - 1999
Position:	
Notes:	
OE Number:	1112350, 1619930, 3E7570

Engine Oil Pressure Sensor 904-7027



Make:	Freightliner
Applications:	Caterpillar C15 engines 2004 - 2005
Position:	
Notes:	
OE Number:	1946725

Engine Oil Pressure Sensor 904-7109



Make:	Freightliner
Applications:	Cummins ISX engines 2000 - 2003
Position:	
Notes:	
OE Number:	4921475, 4921475

Engine Oil Pressure Sensor 904-7241



Make:	Freightliner
Applications:	Cummins ISM 10.8 engines 2000 - 2002
Position:	
Notes:	
OE Number:	4921477, 4921477

FREIGHTLINER

Exhaust Manifold – Fog Light Assembly

Exhaust Manifold		764-5002
		
Make:	Freightliner	
Applications:	Caterpillar C16 engines 2001 - 2004	
Position:		
Notes:	Includes gaskets and hardware	
OE Number:	1501914, CT1333359	

Exterior Door Handle		760-5201
		
Make:	Freightliner	
Applications:	Columbia 2003 - 2010	
Position:	Front Right	
Notes:	Black and Chrome	
OE Number:	A18-42228-003	

Exterior Door Handle		760-5202
		
Make:	Freightliner	
Applications:	Columbia 2003 - 2010	
Position:	Front Left	
Notes:	Black and Chrome	
OE Number:	A18-42228-000	

Exterior Door Handle		760-5203
		
Make:	Freightliner	
Applications:	Condor 2003 - 2005	
Position:	Front Left	
Notes:	Black and Chrome	
OE Number:	A18-42228-002	

Exterior Door Handle		760-5204
		
Make:	Freightliner	
Applications:	Condor 2003 - 2005	
Position:	Front Right	
Notes:	Black and Chrome	
OE Number:	A18-42228-001	

Exterior Door Handle		760-5205
		
Make:	Freightliner	
Applications:	Classic, FLD 120, FLD120 SD 1991 - 2009	
Position:	Front Left	
Notes:	Black and Chrome	
OE Number:	A18-35381-000	

Exterior Door Handle		760-5206
		
Make:	Freightliner	
Applications:	Classic, FLD 120, FLD120 SD 1991 - 2009	
Position:	Front Right	
Notes:	Black and Chrome	
OE Number:	A18-35381-001	

Exterior Door Handle		760-5207
		
Make:	Freightliner	
Applications:	Cascadia, M2, M2 106, M2 112 2008 - 2011	
Position:	Front Right	
Notes:	Black	
OE Number:	A18-47729-003, A18-53241-001	

Exterior Door Handle		760-5208
		
Make:	Freightliner	
Applications:	Cascadia, M2, M2 106, M2 112 2008 - 2011	
Position:	Front Left	
Notes:	Black	
OE Number:	A1847729000, A1847729002, A18-53241-000	

Exterior Door Handle		760-5209
		
Make:	Freightliner	
Applications:	FL 106, FL106, FL112, FL50, FL60, FL70, FL80, FLC 112 1991 - 2005	
Position:	Front Right	
Notes:	Black	
OE Number:	6807600170	

Exterior Door Handle		760-5210
		
Make:	Freightliner	
Applications:	FL 106, FL106, FL112, FL50, FL60, FL70, FL80, FLC 112 1991 - 2005	
Position:	Front Left	
Notes:	Black	
OE Number:	6807600070	

Fog Light Assembly		888-5207
		
Make:	Freightliner	
Applications:	Cascadia 2009 - 2012	
Position:	Right	
Notes:	Bulbs included	
OE Number:	A06-51908-001	

Fog Light Assembly **888-5208**



Make:	Freightliner
Applications:	Cascadia 2009 - 2012
Position:	Left
Notes:	Bulbs included
OE Number:	A06-51908-000

Fog Light Assembly **924-5201**



Make:	Freightliner
Applications:	Columbia 2004 - 2010
Position:	Left, Right
Notes:	Bulbs included
OE Number:	06-32750-000, A06-75742-000

Fuel Pressure Sensor **904-7018**



Make:	Freightliner
Applications:	Caterpillar C15 engines 2006 - 2008
Position:	
Notes:	
OE Number:	2482168, 2842728

Fuel Pressure Sensor **904-7029**



Make:	Freightliner
Applications:	Caterpillar C7 engines 2005 - 2007
Position:	
Notes:	
OE Number:	2482169

Fuel Tank Sending Unit **285-5203**



Make:	Freightliner
Applications:	FL106, FL50, FL60, FL70, FL80, FLD 120, FLD120 SD 1994 - 1999
Position:	
Notes:	With 80 gallon 23 inch diameter tank, Includes gaskets and hardware
OE Number:	A22-42390-005

Fuel Tank Sending Unit **285-5207**



Make:	Freightliner
Applications:	Business Class M2, Cascadia, Century, Columbia, Coronado, M2, M2 100, M2 106, M2 112 2002 - 2012
Position:	Front
Notes:	With 25 inch diameter tank, Includes gaskets and hardware
OE Number:	A22-43065-003

Fuel Tank Strap **578-5201**



Make:	Freightliner
Applications:	All Freightliner models 2000 - 2011
Position:	
Notes:	23 inch diameter round tanks
OE Number:	A0338910000

Grille **242-5201**



Make:	Freightliner
Applications:	Cascadia, Cascadia 113, Cascadia 125 2008 - 2016
Position:	
Notes:	Chrome, Includes Mounting Hardware and Bug Screen
OE Number:	A17-15624-003, A17-19112-000, A17-19112-007, A17-19112-011

Grille **242-5202**



Make:	Freightliner
Applications:	Columbia, Columbia 112, Columbia 120 2000 - 2014
Position:	
Notes:	Chrome, Includes Mounting Hardware and Bug Screen
OE Number:	A17-15251-000, A17-15251-001, A17-15251-002, A17-15251-003

Grille **242-5208**



Make:	Freightliner
Applications:	M2 106, SAF-T-LINER C2 2003 - 2015
Position:	
Notes:	Chrome, Includes Mounting Hardware and Bug Screen
OE Number:	A1714787001

Handle - Walk Plate Spring Release **924-5212**



Make:	Freightliner
Applications:	Columbia 2005 - 2010
Position:	
Notes:	
OE Number:	2243882001

Headlight Assembly **888-5201**



Make:	Freightliner
Applications:	Columbia, Columbia 112, Columbia 120 2004 - 2016
Position:	Right
Notes:	Bulbs included
OE Number:	A06-32496-005, A06-32496-007, A06-46108-001, A06-51041-001, A06-75737-003, A06-75737-005

FREIGHTLINER

Headlight Assembly – Headlight Bezel

Headlight Assembly	888-5202
	
Make:	Freightliner
Applications:	Columbia, Columbia 112, Columbia 120 2004 - 2016
Position:	Left
Notes:	Bulbs included
OE Number:	A06-32496-004, A06-32496-006, A06-46108-000, A06-51041-000, A06-51041-002, A06-75737-002, A06-75737-004

Headlight Assembly	888-5203
	
Make:	Freightliner
Applications:	M2, M2 100, M2 106, M2 112 2002 - 2016
Position:	Right
Notes:	Bulbs included
OE Number:	A06-35853-001, A06-51039-001, A06-51039-003, A06-75732-001, A06-75732-003, A06-75732-005

Headlight Assembly	888-5204
	
Make:	Freightliner
Applications:	M2, M2 106, M2 112 2003 - 2016
Position:	Left
Notes:	Bulbs included
OE Number:	A06-35853-000, A06-51039-000, A06-51039-002, A06-75732-002, A06-75732-004

Headlight Assembly	888-5205
	
Make:	Freightliner
Applications:	Cascadia, Cascadia 113, Cascadia 125 2008 - 2016
Position:	Right
Notes:	Bulbs included
OE Number:	A06-51907-001, A06-51907-003, A06-51907-007

Headlight Assembly	888-5206
	
Make:	Freightliner
Applications:	Cascadia, Cascadia 113, Cascadia 125 2008 - 2016
Position:	Left
Notes:	Bulbs included
OE Number:	A06-51907-000, A06-51907-002, A06-51907-006

Headlight Bezel	889-5201
	
Make:	Freightliner
Applications:	Columbia 2004 - 2010
Position:	Right
Notes:	Chrome
OE Number:	06-32242-003

Headlight Bezel	889-5202
	
Make:	Freightliner
Applications:	Columbia 2004 - 2010
Position:	Left
Notes:	Chrome
OE Number:	06-32242-002

Headlight Bezel	889-5203
	
Make:	Freightliner
Applications:	Business Class M2, M2, M2 100, M2 106, M2 112 2002 - 2016
Position:	Right
Notes:	Chrome
OE Number:	A1714930001

Headlight Bezel	889-5204
	
Make:	Freightliner
Applications:	Business Class M2, M2, M2 100, M2 106, M2 112 2002 - 2016
Position:	Left
Notes:	Chrome
OE Number:	A1714930000

Headlight Bezel	889-5207
	
Make:	Freightliner
Applications:	FLD 120, FLD120 SD 1990 - 1996
Position:	Right
Notes:	w/Cornering Lamps
OE Number:	A06-20738-001

Headlight Bezel	889-5208
	
Make:	Freightliner
Applications:	FLD 120, FLD120 SD 1990 - 1996
Position:	Left
Notes:	w/Cornering Lamps
OE Number:	A06-20738-000

Headlight Bezel	889-5209
	
Make:	Freightliner
Applications:	Century, Century 112, Century 120, Century C112, Century C120, Century Class, Century CST112, Century CST120 1996 - 2004
Position:	Right
Notes:	Black, Paintable
OE Number:	A06-20711-001

FREIGHTLINER

Headlight Bezel – Hood Latch Assembly

Headlight Bezel 889-5210



Make:	Freightliner
Applications:	Century, Century 112, Century 120, Century C112, Century C120, Century Class, Century CST112, Century CST120 1996 - 2004
Position:	Left
Notes:	Black, Paintable
OE Number:	A06-20711-000

Headlight Bezel 889-5211



Make:	Freightliner
Applications:	Century, Century 112, Century 120, Century C112, Century C120, Century Class, Century CST112, Century CST120 1996 - 2004
Position:	Left
Notes:	Chrome
OE Number:	A0620711002

Headlight Bezel 889-5212



Make:	Freightliner
Applications:	Century, Century 112, Century 120, Century C112, Century C120, Century Class, Century CST112, Century CST120 1996 - 2004
Position:	Right
Notes:	Chrome
OE Number:	A0620711003

Headlight Switch 901-5206



Make:	Freightliner
Applications:	Columbia 2003 - 2010
Position:	
Notes:	
OE Number:	A06-30769-010

Hood Hinge Spring 938-5201



Make:	Freightliner
Applications:	FLD 120, FLD 132, FLD120 SD 1990 - 2008
Position:	
Notes:	Classic
OE Number:	17-12069-001, A17-12069-001

Hood Latch Assembly 315-5201



Make:	Freightliner
Applications:	Classic 2003 - 2008
Position:	Left, Right
Notes:	Contains all brackets
OE Number:	17-12348-000, 17-12438-000

Hood Latch Assembly 315-5202



Make:	Freightliner
Applications:	Columbia 2003 - 2008
Position:	Right
Notes:	Contains all brackets
OE Number:	A17-15553-001

Hood Latch Assembly 315-5203



Make:	Freightliner
Applications:	Columbia 2003 - 2008
Position:	Left
Notes:	Contains all brackets
OE Number:	A17-15553-000

Hood Latch Assembly 315-5204



Make:	Freightliner
Applications:	Classic 2003 - 2009
Position:	Right
Notes:	Contains all brackets
OE Number:	17-12435-001

Hood Latch Assembly 315-5205



Make:	Freightliner
Applications:	Classic 2003 - 2008
Position:	Left
Notes:	Contains all brackets
OE Number:	17-12435-000

Hood Latch Assembly 315-5206



Make:	Freightliner
Applications:	FL106, FL112, FL50, FL60, FL70, FL80 1994 - 2005
Position:	
Notes:	Contains all brackets
OE Number:	6808800160

Hood Latch Assembly 315-5207



Make:	Freightliner
Applications:	Century C112, Century C120, Century CST112, Century CST120 1996 - 2004
Position:	Right
Notes:	Contains all brackets
OE Number:	A1712658003

FREIGHTLINER

Hood Mirror – Interior Door Handle

Hood Mirror	955-5204
	
Make:	Freightliner
Applications:	Cascadia, Cascadia 113, Cascadia 125 2008 - 2015
Position:	Left
Notes:	Auxiliary Mirror, Manual, wo/Heat, Black/Chrome
OE Number:	A22-66565-003

Hood Mirror	955-5205
	
Make:	Freightliner
Applications:	Cascadia, Cascadia 113, Cascadia 125 2008 - 2015
Position:	Right
Notes:	Auxiliary Mirror, Manual, wo/Heat, Black/Chrome
OE Number:	A22-66565-002

Hood Mirror Glass	955-5206
	
Make:	Freightliner
Applications:	Cascadia, Cascadia 113, Cascadia 125 2008 - 2015
Position:	Left
Notes:	
OE Number:	28729C, TL28729

Hood Restraint Cable	924-5206
	
Make:	Freightliner
Applications:	Classic, FLC 112, FLD 120, FLD120 SD, SAF-T-LINER FS-65 1989 - 2007
Position:	
Notes:	Long
OE Number:	A17-12082-000

Hood Restraint Cable	924-5207
	
Make:	Freightliner
Applications:	Classic, FLC 112, FLD 120, FLD120 SD, SAF-T-LINER FS-65 1989 - 2007
Position:	
Notes:	Short
OE Number:	A17-12081-000

Hood Stop Buffer	924-5202
	
Make:	Freightliner
Applications:	Columbia 2003 - 2008
Position:	Left
Notes:	
OE Number:	A17-13787-002

Hood Stop Buffer	924-5203
	
Make:	Freightliner
Applications:	Columbia 2003 - 2008
Position:	Right
Notes:	
OE Number:	A17-13787-003

Hood Stop Buffer	924-5222
	
Make:	Freightliner
Applications:	Century, Century 112, Century 120, Century Class 1996 - 2005
Position:	Right
Notes:	
OE Number:	A1713534001

Hood Stop Buffer	924-5223
	
Make:	Freightliner
Applications:	Century Class 1996 - 2005
Position:	Left
Notes:	
OE Number:	A1713534000

HVAC Heater Blend Door Actuator	604-5120
	
Make:	Freightliner
Applications:	Century Class, Century CST112, Century CST120, Columbia, Columbia 112, Columbia 120, Coronado, Coronado 122, Coronado 132 2003 - 2015
Position:	
Notes:	For Main Cab Unit, 6 Pin Connector, Label ID No. A7583003, For Sleeper Cab Unit, 6 Pin Connector, Label ID No. A7583003
OE Number:	11-0660, 1322, 2113009, S-20436

HVAC Heater Control Cable	924-5210
	
Make:	Freightliner
Applications:	FL80 1997 - 2002
Position:	
Notes:	
OE Number:	22-49905-000, 2512005, FA1350

Interior Door Handle	761-5201
	
Make:	Freightliner
Applications:	Century, Century Class, Century CST112, Century CST120, Columbia, Columbia 112, Columbia 120 2004 - 2011
Position:	Left
Notes:	Matching color
OE Number:	18-39533-000, 18-41717-000, 1848225000

Interior Door Handle **761-5202**



Make:	Freightliner
Applications:	Cascadia, Cascadia 113, Cascadia 125 2009 - 2012
Position:	
Notes:	Cabinet Latch Handle
OE Number:	A1859019000

Interior Door Handle **761-5204**



Make:	Freightliner
Applications:	Business Class M2, Cascadia, Cascadia 113, Cascadia 125, Coronado, Coronado 122, Coronado 132, M2, M2 100, M2 106, M2 112 2003 - 2013
Position:	Front Right
Notes:	Black
OE Number:	18-41717-001, 18-48225-001, A18-46490-001

Interior Door Handle **761-5205**



Make:	Freightliner
Applications:	FLA086, FLC 112, FLC 120, FLC112, FLC120 1981 - 2001
Position:	Front Left
Notes:	Black
OE Number:	A18-65867-002

Interior Door Handle **761-5215**



Make:	Freightliner
Applications:	Business Class M2, Cascadia, Cascadia 113, Cascadia 125, Coronado, Coronado 122, Coronado 132, M2, M2 100, M2 106, M2 112 2003 - 2013
Position:	Front Left
Notes:	Chrome
OE Number:	A18-46490-000

Interior Door Handle **761-5216**



Make:	Freightliner
Applications:	Business Class M2, Cascadia, Cascadia 113, Cascadia 125, Coronado, Coronado 122, Coronado 132, M2, M2 100, M2 106, M2 112 2003 - 2013
Position:	Front Right
Notes:	Chrome
OE Number:	A18-46490-001

Leaf Spring Support **924-5229**



Make:	Freightliner
Applications:	Columbia, Columbia 112, Columbia 120 2001 - 2010
Position:	Front
Notes:	35MM X 101.6MM
OE Number:	1615105080

Manifold Absolute Pressure Sensor **904-7033**



Make:	Freightliner
Applications:	Caterpillar C12 engines 2000 - 2000
Position:	Manifold
Notes:	
OE Number:	1619929, 1946724

Manifold Absolute Pressure Sensor **904-7037**



Make:	Freightliner
Applications:	Caterpillar C11 engines 2003 - 2006
Position:	Manifold
Notes:	
OE Number:	2393478

Manifold Absolute Pressure Sensor **904-7107**



Make:	Freightliner
Applications:	Cummins ISX 15 engines 2002 - 2006
Position:	Manifold
Notes:	
OE Number:	4928593

Manifold Absolute Pressure Sensor **904-7124**



Make:	Freightliner
Applications:	Cargo, Century Class, FC70, FC80, FL50, FL60, FL70, FL80, FS65, K300, Low Entry, MT45, MT55, with Cummins ISB 5.9 Engine 1999 - 2002
Position:	Manifold
Notes:	
OE Number:	4921497

Manifold Absolute Pressure Sensor **904-7142**



Make:	Freightliner
Applications:	Cummins ISX 15 engines 2000 - 2000
Position:	
Notes:	
OE Number:	4921473

Multi Function Switch **978-5201**



Make:	Freightliner
Applications:	3300 CE, C2, M2, M2 106, M2 112, SAF-T-LINER C2 2003 - 2015
Position:	
Notes:	Black
OE Number:	A06-36956-002, A0636956003

FREIGHTLINER

Multi Function Switch – Truck Cab Side Step

Multi Function Switch 978-5204



Make:	Freightliner
Applications:	Century, Century C112, Century C120, Century Class, Century CST112, Century CST120, Columbia, Columbia 120, Coronado, Coronado 132 1998 - 2003
Position:	
Notes:	Black, Non-Self Canceling
OE Number:	A14-13495-000

Multi Function Switch 978-5210



Make:	Freightliner
Applications:	FS65, SAF-T-LINER FS-65 2002 - 2007
Position:	
Notes:	Shadow Gray, Self Canceling
OE Number:	A06-22743-002

Multi Function Switch 978-5211



Make:	Freightliner
Applications:	Century, Century 112, Century 120, Century C112, Century C120, Century Class, Century CST112, Century CST120, Columbia, Columbia 112, Columbia 120, MT35, MT45, MT55 1996 - 2015
Position:	
Notes:	Black, Self Canceling
OE Number:	A06-44025-000

Power Window Motor and Regulator Assembly 741-5201



Make:	Freightliner
Applications:	Columbia, Columbia 112, Columbia 120, FLD 112, FLD 120, FLD 132, FLD120 SD 1996 - 2013
Position:	Front Left
Notes:	Power Window Regulator w/Motor
OE Number:	A18-48952-001

Power Window Motor and Regulator Assembly 741-5202



Make:	Freightliner
Applications:	Columbia, Columbia 112, Columbia 120, FLD 112, FLD 120, FLD 132, FLD120 SD 1996 - 2013
Position:	Front Right
Notes:	Power Window Regulator w/Motor
OE Number:	A18-48952-000

Power Window Motor and Regulator Assembly 741-5203



Make:	Freightliner
Applications:	Argosy, Century 1997 - 2010
Position:	Front Right
Notes:	Power Window Regulator w/Motor
OE Number:	A18-52044-001

Power Window Motor and Regulator Assembly 741-5204



Make:	Freightliner
Applications:	Argosy, Century 1997 - 2010
Position:	Front Left
Notes:	Power Window Regulator w/Motor
OE Number:	A18-52044-000

Sensor - Auto Transmission Speed 904-7026



Make:	Freightliner
Applications:	Caterpillar C11 engines 2004 - 2006
Position:	Input
Notes:	
OE Number:	2016616

Throttle Body Motor 341-5001



Make:	Freightliner
Applications:	Detroit Diesel DD13, DD15, DD16, DD60 series engines 1987 - 2015
Position:	
Notes:	Remanufactured
OE Number:	A4600980210, A4600980310, RA4600900065

Truck Cab Side Step 157-5201



Make:	Freightliner
Applications:	Columbia, Columbia 112, Columbia 120 2001 - 2010
Position:	
Notes:	47.5 In. x 5.25 In. w/120 Gallon Tank
OE Number:	A2257757120

Truck Cab Side Step 157-5202



Make:	Freightliner
Applications:	Cascadia, Cascadia 113, Cascadia 125, M2, M2 100, M2 106, M2 112 2003 - 2015
Position:	
Notes:	40 In. x 5.25 In w/60 Gallon Tank (23 In. Diameter)
OE Number:	A2257757090

Truck Cab Side Step 157-5203



Make:	Freightliner
Applications:	Cascadia, Cascadia 113, Cascadia 125, FLD 112, FLD 120, FLD 132, FLD120 SD, M2, M2 100, M2 106, M2 112 1998 - 2015
Position:	
Notes:	59.3 In. x 5.25 In.w/100 Gallon Tank (25 In. Diameter)
OE Number:	A2257757150

Turbocharger Boost Pressure Valve 599-5001



Make: Freightliner
Applications: Cummins ISM 10.8, ISX 15 2005 - 2007
Position:
Notes: Remanufactured
OE Number: 2836554, 3770742, 4036195, 4037440, 4039813, 4040589, 4046304

Turbocharger Boost Sensor 904-7015



Make: Freightliner
Applications: Caterpillar 3126 engines 1995 - 1996
Position:
Notes: Outlet
OE Number: 1112351, 1212728, 1414120, 1619927, 3E6379

Turbocharger Boost Sensor 904-7028



Make: Freightliner
Applications: Caterpillar 3126 engines 1997 - 1998
Position:
Notes: Inlet
OE Number: 1414119, 1619925, 1946722

Turbocharger Boost Sensor 904-7254



Make: Freightliner
Applications: Detroit Diesel Series 60 engines 2007 - 2007
Position:
Notes:
OE Number: 23527829

Turbocharger Intercooler Hose 341-5010



Make: Freightliner
Applications: Columbia, Columbia 112, Columbia 120 2003 - 2007
Position:
Notes: w/ 2003 EPA Standard
OE Number: 01-28096-002

Turbocharger Speed Sensor 904-7111



Make: Freightliner
Applications: Cummins ISX 11.9, ISX 15 2010 - 2011
Position:
Notes: 2010EPA Standard
OE Number: 4032173

Turbocharger Speed Sensor 904-7139



Make: Freightliner
Applications: ISB 200, ISB 6.7, ISB6.7, ISB6.7-200, ISB6.7-220, ISB6.7-240, ISB6.7-260, ISB6.7-280 2009 - 2010
Position:
Notes:
OE Number: 4032315

Turbocharger Speed Sensor 904-7146



Make: Freightliner
Applications: ISB 200, ISB 6.7, ISB6.7, ISB6.7-200, ISB6.7-220, ISB6.7-240, ISB6.7-260, ISB6.7-280 2011 - 2016
Position:
Notes:
OE Number: 4032806

Turn Signal Light Assembly 888-5200

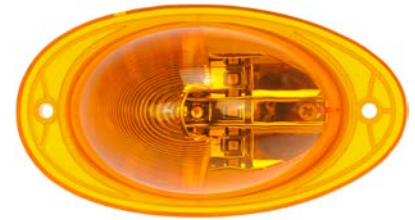

Make: Freightliner
Applications: Cascadia, Cascadia 113, Cascadia 125 2008 - 2014
Position: Left, Right
Notes: Auxiliary Light, LED
OE Number: A06-58770-000

Vehicle Speed Sensor 505-5201



Make: Freightliner
Applications: Argosy, Cargo, Cascadia, Century, Century 112, Century 120, Classic, Columbia, Condor, Coronado, FC70, FC80, FL106, FL50, FL60, FL70, FL80, FLC 112, FLD 120, FLD120 SD, FS65, M2, M2 106, M2 112, MB 80, MB60, MB70, MT35, MT45, Severe-Duty FLD 1989 - 2011
Position:
Notes: w/Merritor Transmission, Screw In Style, w/Internal Tone Ring
OE Number: SAA85920008

Washer Fluid Reservoir 603-5204



Make: Freightliner
Applications: Cascadia 2008 - 2012
Position:
Notes: Includes caps, pump, and level sensors (where applicable)
OE Number: A22-60952-004

Washer Fluid Reservoir 603-5214



Make: Freightliner
Applications: M2, M2 100, M2 106, M2 112 2004 - 2010
Position:
Notes: Includes caps, pump, and level sensors (where applicable)
OE Number: A22-58778-000, A2262487000

FREIGHTLINER

Washer Reservoir Cap – Windshield Washer Nozzle

Washer Reservoir Cap	902-5404 📧
	
Make:	Freightliner
Applications:	FLD120 SD 1990 - 2005
Position:	
Notes:	Fill Cap
OE Number:	63361

Window Crank Handle	775-5201 📧
	
Make:	Freightliner
Applications:	Classic, FLD 120, FLD120 SD, Severe-Duty FLD 1991 - 2009
Position:	Left, Right
Notes:	Black Handle, w/Black Knob
OE Number:	A18-18557-002

Window Crank Handle	775-5202
	
Make:	Freightliner
Applications:	Business Class M2, M2, M2 100, M2 106, M2 112 2002 - 2015
Position:	Left, Right
Notes:	Black
OE Number:	A18-43563-000

Windshield Washer Nozzle	924-5224
	
Make:	Freightliner
Applications:	Columbia, Columbia 112, Columbia 120 2000 - 2012
Position:	Front
Notes:	Includes washer hose and nozzle
OE Number:	F88171405

Windshield Washer Nozzle	924-5225
	
Make:	Freightliner
Applications:	Cascadia, Cascadia 113, Cascadia 125 2009 - 2012
Position:	Front
Notes:	Nozzle only
OE Number:	F88171801

Windshield Washer Nozzle	924-5226
	
Make:	Freightliner
Applications:	FLD 120, FLD120 SD 1999 - 2010
Position:	Front
Notes:	Nozzle only
OE Number:	GW254

BE THE FIRST TO KNOW! 📧
ABOUT FORMERLY "DEALER ONLY" PARTS

NEW FORMERLY "DEALER ONLY" PARTS ARE ADDED MONTHLY!

The Be-The-First-To-Know program keeps you updated with email and text announcements

SIGN UP TODAY!

DormanHDSolutions.com/btftk

Battery Cover 242-5106



Make:	International
Applications:	2554, 2574, 2654, 2674, 3000, 3000RE, 4700, 4700LP, 4700LPX, 4800, 4900 1997 - 2005
Position:	
Notes:	
OE Number:	2029260C2

Brake Light Switch 901-0001



Make:	International
Applications:	3200, 4100, 4100 SBA, 4200, 4200LP, 4300, 4300LP, 4400, 4400LP, CE, RXT, TerraStar 2001 - 2016
Position:	
Notes:	
OE Number:	2505677C91, 5005836

Dashboard Air Vent 216-5101



Make:	International
Applications:	4700, 4700LP, 4700LPX, 4800, 4900, 5900i SBA, 7000, 7300, 7300 SBA, 7400, 7500, 7600, 7700, 8000, 8500 TranStar, 8600 TranStar, 9100i SBA, 9200i SBA, 9400i SBA, 9900i, 9900i SFA, 9900ix, 9900ix SFA 2001 - 2011
Position:	Center; Left; Right
Notes:	Black
OE Number:	3529263C1

Diesel Particulate Filter Clamp 674-9000



Make:	International
Applications:	Cummins ISX Engines 2007 - 2015
Position:	
Notes:	w/2007 & 2010 EPA Standards
OE Number:	21445455

Door Hinge 924-5103



Make:	International
Applications:	4700LPX, 8000, 8500 TranStar, 8600 TranStar, CXT, MXT, ProStar, RXT, TerraStar 2002 - 2016
Position:	Right, Left
Notes:	Front
OE Number:	3549259C2, 3549259C1

Door Mirror Bracket 924-5105



Make:	International
Applications:	3000, 3000RE, 3200, 3300, 4700LPX, 8000, 8500 TranStar, 8600 TranStar, LoneStar, ProStar, RXT, TerraStar 2002 - 2011
Position:	Left
Notes:	Lower
OE Number:	2597071C91

Door Mirror Bracket 924-5106



Make:	International
Applications:	3000, 3000RE, 3200, 3300, 4700LPX, LoneStar, ProStar, RXT, TerraStar 2002 - 2012
Position:	Right
Notes:	Lower
OE Number:	2597075C91

Door Seal 750-5102



Make:	International
Applications:	3200, 4100, 4100 SBA, 4200, 4200LP, 4300, 4300LP, 4400, 4400LP, 7300, 7300 SBA, 7300 SFA, 7400, 7500, 7600, 7700, 8500, 8500 SBA, 8600, 8600 SBA, CXT, LoneStar, MXT, ProStar, RXT, TerraStar 1990 - 2014
Position:	Left
Notes:	Primary Door Seal
OE Number:	3508972C6

Door Seal 750-5103



Make:	International
Applications:	3200, 4100, 4100 SBA, 4200, 4200LP, 4300, 4300LP, 4400, 4400LP, 7300, 7300 SBA, 7300 SFA, 7400, 7500, 7600, 7700, 8500, 8500 SBA, 8600, CXT, LoneStar, MXT, ProStar, RXT, TerraStar 1990 - 2014
Position:	Left
Notes:	Secondary Door Seal
OE Number:	3508975C7

Door Seal 750-5104



Make:	International
Applications:	3200, 4100, 4100 SBA, 4200, 4200LP, 4300, 4300LP, 4400, 4400LP, 7300, 7300 SBA, 7300 SFA, 7400, 7500, 7600, 7700, 8500, 8500 SBA, 8600, 8600 SBA, CXT, LoneStar, MXT, ProStar, RXT, TerraStar 1990 - 2014
Position:	Right
Notes:	Secondary Door Seal
OE Number:	3508976C7

EGR Cooler 904-5020



Make:	International
Applications:	DT466, DT570, HT570 2004 - 2009
Position:	
Notes:	Round Cooler; 11.5 Inches Long. Includes all gaskets and hardware
OE Number:	1871733C95, 1871733C93, 1871733C92

EGR Cooler 904-5023



Make:	International
Applications:	DT466, DT570, HT570 2004 - 2009
Position:	
Notes:	Square Cooler; 21 Inches Long. Includes all gaskets and hardware
OE Number:	1832542C94, 1832542C93, 1832542C91, 1832542C92

INTERNATIONAL

EGR Cooler – Engine Camshaft Position Sensor

EGR Cooler	904-5035
	
Make:	International
Applications:	Cummins ISX 15 2003 - 2007
Position:	
Notes:	Includes all gaskets and hardware
OE Number:	2881783, 3682986, 4089436, 3683435, 4952490, 4956008NX, 4089166, 4956008, 2881783NX, 3683253, 2878071, 3683069, 2869133, 3682806

EGR Cooler	904-5036
	
Make:	International
Applications:	Cummins ISM 2003 - 2007
Position:	
Notes:	Includes all gaskets and hardware
OE Number:	4089380, 3102803, 4089380NX

EGR Cooler Gasket Kit	904-5007
	
Make:	International
Applications:	Cummins Gen 1 ISX 15.0, ISX 15.0, CL700 SubModel, ISX-400, ISX-450, ISX-475, ISX-500, ISX-565, ISX-600 2003 - 2007
Position:	
Notes:	Includes all gaskets and hardware
OE Number:	4309434NX

EGR Cooler Gasket Kit	904-5008
	
Make:	International
Applications:	ISX 15.0, ISX-400, ISX-450, ISX-475, ISX-500, ISX-565, ISX-600 2007 - 2010
Position:	
Notes:	Generation 2, Includes all gaskets and hardware
OE Number:	2881784, 4309398, 4309248, 4309248NX, 4955467, 3684448, 2881747, 2881784NX, 2881747NX, 4955926, 4309398NX

EGR Cooler Gasket Kit	904-5010
	
Make:	International
Applications:	Cummins ISM 2002 - 2006
Position:	
Notes:	Generation 1, Includes all gaskets and hardware
OE Number:	4089380NX

EGR Cooler Gasket Kit	904-5011
	
Make:	International
Applications:	Cummins ISM 10.8 2007 - 2010
Position:	
Notes:	Generation 2, Includes all gaskets and hardware
OE Number:	2881725NX

EGR Valve	904-5001
	
Make:	International
Applications:	Cummins ISX 2003 - 2007
Position:	
Notes:	Fits Engines Manufactured From 09/31/2002, Generation 1, Includes all gaskets and mounting hardware
OE Number:	4955422RX, 3683305, 3682974, 3682954, 3104874, 3682805, 4955422, 4955422NX, 3684004, 3683446

EGR Valve	904-5002
	
Make:	International
Applications:	Cummins ISM 2003 - 2007
Position:	
Notes:	Fits Engines Manufactured From 09/31/2002, Generation 1, Includes all gaskets and mounting hardware
OE Number:	4921905, 3104875, 4955421, 3103765, 4955421RX, 3103824, 3103361, 2102745

EGR Valve 	904-5056
	
Make:	International
Applications:	Maxxforce DT engines 2007 - 2010
Position:	
Notes:	2007 EPA standard, Includes gaskets and hardware
OE Number:	1878918C1, 1873842C92, 1878918C2, 1875808C1

EGR Valve 	904-5062
	
Make:	International
Applications:	DT466 engines 2003-2006
Position:	
Notes:	2003 EPA standard, Includes gaskets and hardware
OE Number:	1842593C92, 1842593C91

Engine Camshaft Position Sensor	505-5110
	
Make:	International
Applications:	DT466, DT570 1997 - 2004
Position:	
Notes:	Includes Shims
OE Number:	F7TZ12K073, 1885812C91, 1807339C92, 1807339C93

Engine Camshaft Position Sensor	904-7017
	
Make:	International
Applications:	Caterpillar C15 engines 2004 - 2005
Position:	Center Upper
Notes:	
OE Number:	2016617

Engine Coolant Reservoir 	603-5101
	
Make:	International
Applications:	3800, 3800 CE, 4700, 4700LP, 4700LPX, 4800, 4900 1995 - 2004
Position:	
Notes:	Includes caps, pump, and level sensors (where applicable)
OE Number:	2002105C2, 5C4Z8A080A, 2002105C3

Engine Coolant Reservoir 	603-5103
	
Make:	International
Applications:	9100i SBA, 9200, 9200i SBA, 9400, 9400i SBA, 9800, 9900i, 9900i SFA, 9900ix, 9900ix SFA 2003 - 2010
Position:	
Notes:	Includes caps, pump, and level sensors (where applicable)
OE Number:	2508700C92, 2508700C91, 2508700C93, 3565217F93



Engine Coolant Reservoir 	603-5104
	
Make:	International
Applications:	3200, 4100, 4100 SBA, 4200, 4200LP, 4300, 4300LP, 4400, 7300, 7300 SBA, 7300 SFA, 8500, 8500 SBA, 8500 TranStar, CE 1990 - 2016
Position:	
Notes:	Includes caps, pump, and level sensors (where applicable), w/ dual vacuum ports
OE Number:	2602943C91



Engine Coolant Reservoir 	603-5107
	
Make:	International
Applications:	7300, 7300 SBA, 7300 SFA, 7400, 7500, CXT, MXT 2001 - 2011
Position:	
Notes:	Includes caps, pump, and level sensors (where applicable), w/o vacuum ports
OE Number:	2587216C1, 2591802C1



Engine Coolant Reservoir 	603-5110
	
Make:	International
Applications:	1300, 3200, 3300, 4100, 4100 SBA, 4200, 4200LP, 4300, 4300LP, 4400, 4400LP, 8500, 8500 SBA, 8500 TranStar, BE, CE, F650 1990 - 2016
Position:	Front
Notes:	1 port, Includes caps, pump, and level sensors (where applicable)
OE Number:	2602872C91, 2599039C91, 3578833C3, 4C4Z8B379A, 2602935C91, BC4Z8A080A, 2587324C1, 2591625C92, 2039390C3



Engine Coolant Reservoir Cap 	902-5101 
	
Make:	International
Applications:	2000, 2554, 4100, 4200, 4200LP, 4300, 4300LP, 4400, 4400LP, 4700, 4700LP, 4700LPX, 4800, 4900 2002 - 2008
Position:	
Notes:	10 PSI
OE Number:	2039390C3, 4C4Z8100A

Engine Coolant Reservoir Cap 	902-5102 
	
Make:	International
Applications:	9200, 9200i SBA, 9400, 9900i, 9900i SFA, 9900ix, 9900ix SFA 2003 - 2010
Position:	
Notes:	15 PSI
OE Number:	4C4Z8100B, 3578833C3, 3578833C2

Engine Coolant Temperature Sensor 	505-5101
	
Make:	International
Applications:	DT466 1989 - 2000
Position:	
Notes:	
OE Number:	1675751C1, 4C407H141B

Engine Coolant Temperature Sensor 	904-7039
	
Make:	International
Applications:	Caterpillar 3406 engines 1994 - 1997
Position:	
Notes:	
OE Number:	1022240

Engine Crankshaft Position Sensor 	904-7020
	
Make:	International
Applications:	Caterpillar 3126BTA6 engines 2002 - 2003
Position:	Rear Left Rearward
Notes:	
OE Number:	1693300, 1194142, 2454630

Engine Crankshaft Position Sensor 	904-7021
	
Make:	International
Applications:	Caterpillar C11 engines 2004 - 2006
Position:	Rear Left
Notes:	
OE Number:	2016615

Engine Crankshaft Position Sensor 	904-7516
	
Make:	International
Applications:	MaxxForce 13, V8 363CID 6.0L, V8 365CID 6.0L, V8 391CID 6.4L (6400cc) 2004 - 2015
Position:	
Notes:	
OE Number:	1828345C91, 3C3Z6C315A, DY985

INTERNATIONAL

Engine Mount – Engine Oil Pressure Sensor

Engine Mount		917-5101
		
Make:	International	
Applications:	1652SC, 4200, 4200LP, 4300, 4300LP, 4400, 4400LP, 4700, 4700LP, 4700LPX, 4800, 4900 1999 - 2004	
Position:	Front Left; Front Right; Rear Left; Rear Right	
Notes:		
OE Number:	479237C1	

Engine Mount		917-5102
		
Make:	International	
Applications:	5000, 5070, 5500i, 5600, 5600i, 5900, 5900i, 5900i SBA, 9100 SBA, 9100i SBA, 9200, 9200 SBA, 9200i SBA, 9300, 9400, 9400i SBA, 9600, 9700, 9800, 9800 SBA, 9800 SFA, 9900, 9900 SFA, 9900i, 9900i SFA, 9900ix, 9900ix SFA 1996 - 2009	
Position:	Rear	
Notes:	Mount Insulator	
OE Number:	3515345C1	

Engine Oil Cooler		904-5101
		
Make:	International	
Applications:	1300 FBC, 3000 Chassis, 3000 IC, CE Commercial, CE Integrated, FE Commercial, FE Integrated, FE School Bus, RE Commercial, RE School Bus 2006 - 2009	
Position:		
Notes:	Includes Gaskets and Hardware	
OE Number:	1842417C93, 1842418C3, 1842417C94, 1842417C92, 1842530C93, 1842417C91	

Engine Oil Drain Plug		090-5001
		
Make:	International	
Applications:	Caterpillar 3176, C10, C11, C12, C13, 1989 - 2013	
Position:		
Notes:		
OE Number:	9X6451	

Engine Oil Drain Plug		090-5002
		
Make:	International	
Applications:	Cummins ISL, L10 engines 1974 - 2014	
Position:		
Notes:		
OE Number:	3055069	

Engine Oil Drain Plug		090-5003
		
Make:	International	
Applications:	Cummins ISX 11.9, ISX 11.9G, ISX 15.0 1998 - 2015	
Position:		
Notes:		
OE Number:	4926565	

Engine Oil Drain Plug		090-5004
		
Make:	International	
Applications:	Detroit Diesel Series 60 Engines 1987 - 2015	
Position:		
Notes:		
OE Number:	23505720	

Engine Oil Drain Plug Gasket		095-5001
		
Make:	International	
Applications:	Caterpillar 3176, C10, C11, C12, C13 engines 1989 - 2013	
Position:		
Notes:		
OE Number:	619458	

Engine Oil Drain Plug Gasket		095-5002
		
Make:	International	
Applications:	Cummins ISL, L10 Engines 1981 - 2010	
Position:		
Notes:		
OE Number:	67946	

Engine Oil Drain Plug Gasket		095-5003
		
Make:	International	
Applications:	Cummins ISX 11.9, ISX 15.0 1998 - 2015	
Position:		
Notes:		
OE Number:	3678606	

Engine Oil Pressure Sensor		904-5050
		
Make:	International	
Applications:	Cummins ISX 11.9, ISX 11.9G, ISX 15.0, ISX 2004 - 2016	
Position:		
Notes:		
OE Number:	4921517	

Engine Oil Pressure Sensor		904-7012
		
Make:	International	
Applications:	Caterpillar 3126 engines 1999 - 2000	
Position:		
Notes:		
OE Number:	2244536, 1946726	

Engine Oil Pressure Sensor 904-7016



Make:	International
Applications:	Caterpillar C10 engines 1998 - 1999
Position:	
Notes:	
OE Number:	1619930, 3E7570, 1112350

Engine Oil Pressure Sensor 904-7027



Make:	International
Applications:	Caterpillar C15 engines 2004 - 2005
Position:	
Notes:	
OE Number:	1946725

Engine Oil Pressure Sensor 904-7109



Make:	International
Applications:	Cummins ISX engines 2000 - 2003
Position:	
Notes:	
OE Number:	4921475

Engine Oil Pressure Sensor 904-7241



Make:	International
Applications:	Cummins ISM 10.8 engines 2000 - 2002
Position:	
Notes:	
OE Number:	4921477

Engine Oil Pressure Sensor 904-7512



Make:	International
Applications:	VT365 engines 2002 - 2012
Position:	
Notes:	
OE Number:	1872556C91, 1834538C91, 1839415C91

Exhaust Backpressure Sensor 904-7520



Make:	International
Applications:	DT570 1990 - 2016
Position:	
Notes:	
OE Number:	1850351C1

Exhaust Backpressure Sensor 904-7522



Make:	International
Applications:	VT365, V8 365CID 6.0L, VT365 2005 - 2010
Position:	
Notes:	
OE Number:	5C3Z9J460B, 1850352C2, 1850352C1, 5C3Z9J460A

Exhaust Backpressure Sensor 904-7523



Make:	International
Applications:	IDT466 2008 - 2013
Position:	
Notes:	
OE Number:	1846480C2

Exhaust Manifold 674-5002



Make:	International
Applications:	Caterpillar C16 engines 2001 - 2004
Position:	
Notes:	Includes Gaskets and Hardware
OE Number:	1501914, CT1333359

Exterior Door Handle 760-5101



Make:	International
Applications:	2000, 3000, 3000RE, 3200, 3300, 4700, 4700LP, 4700LPX, 4800, 4900 1997 - 2006
Position:	Front Left; Front Right
Notes:	Black and Chrome
OE Number:	3550925C91, 3550931C91, 1680789C91

Exterior Door Handle 760-5105



Make:	International
Applications:	ProStar 2007 - 2014
Position:	Front Right
Notes:	Chrome Handle
OE Number:	2594006C1

Exterior Door Handle 760-5106



Make:	International
Applications:	ProStar 2007 - 2014
Position:	Front Left
Notes:	Chrome Handle
OE Number:	2594003C1

INTERNATIONAL

Exterior Door Handle – Grille

Exterior Door Handle		760-5107
		
Make:	International	
Applications:	4100, 4200, 4200LP, 4400, 4400LP, 7300, 7300 SFA, 7400, 7500, 7600, 7700, 8500, 8600, 8600 SBA, CXT, MXT, ProStar, RXT 2003 - 2014	
Position:	Front Left	
Notes:	Black Handle	
OE Number:	2587515C1, 3747735C1, 2511119C91	

Exterior Door Handle		760-5108
		
Make:	International	
Applications:	4100, 4200, 4200LP, 4400, 4400LP, 7300, 7300 SFA, 7400, 7500, 7600, 7700, 8500, 8600, 8600 SBA, CXT, MXT, ProStar, RXT 2003 - 2014	
Position:	Front Right	
Notes:	Black Handle	
OE Number:	2505423C1, 2511120C91, 3747736C1	



Exterior Door Handle		760-5110
		
Make:	International	
Applications:	5500i, 5600, 5600i, 5900, 5900i, 5900i SBA, 9100 SBA, 9100i SBA, 9200, 9200 SBA, 9200i SBA, 9400, 9400i SBA, 9800, 9800 SBA, 9800 SFA, 9900, 9900 SFA, 9900i, 9900i SFA, 9900ix, 9900ix SFA 1986 - 2015	
Position:		
Notes:	w/Pawl	
OE Number:	3550930C91	

Fuel Pressure Sensor		904-7018
		
Make:	International	
Applications:	Caterpillar C15 engines 2006 - 2008	
Position:		
Notes:		
OE Number:	2842728, 2482168	

Fuel Pressure Sensor		904-7029
		
Make:	International	
Applications:	Caterpillar C7 engines 2005 - 2007	
Position:		
Notes:		
OE Number:	2482169	

Fuel Tank Sending Unit		285-5101
		
Make:	International	
Applications:	3200, 4100, 4200, 4300, 4400, 4400LP, 5500i, 5600i, 7300, 7300 SBA, 7400, 7500, 7600 2001 - 2011	
Position:		
Notes:	w/16in Diameter Tank, Includes Gaskets and Hardware	
OE Number:	3864392C91, 3864392C92, 3591593C1, 2585993C91	

Fuel Tank Sending Unit		285-5103
		
Make:	International	
Applications:	9200, 9200 SBA, 9200i SBA, 9400, 9400i SBA, 9800, 9800 SBA, 9900, 9900 SFA, 9900i, 9900i SFA, 9900ix, 9900ix SFA 1996 - 2011	
Position:		
Notes:	COE Series Only; w/26in. Diameter Tank, Includes gaskets and hardware	
OE Number:	3596382C92, 3596382C91	

Fuel Tank Sending Unit 		285-5104
		
Make:	International	
Applications:	1652SC, 1652UPS, 3000, 3000RE, 3200, 3300, 3300 CE, 3400, 3600, 3800, 3800 CE, 3900, 4700, 4700LP, 4700LPX, 4800, 4900, 5000, 5500i, 8100 1997 - 2015	
Position:		
Notes:	w/15 In. Deep Tank, Includes gaskets and hardware	
OE Number:	476846C1, 476846C2	

Fuel Tank Sending Unit 		285-5105
		
Make:	International	
Applications:	1452SC, 1652SC, 1652UPS, 2000, 2554, 2654, 3700, 3800, 3800 CE, 3900FC, 4600, 4600LP, 4600UH, 4700, 4700LP, 4800, 4900, 7100, 8000, 9370, 9600, Cargostar, COF5870 Paystar, F1954, G1954, M1400 Metro II, M1600 Metro II, S1654, S1654LP, S1723, S1753, S1754, 1985 - 1991	
Position:		
Notes:	Direct fit, Includes gaskets and hardware	
OE Number:	497840C95, 497840C96, 497840C94	

Fuel Tank Sending Unit		285-5110
		
Make:	International	
Applications:	8600, 8600 SBA, 8600 TranStar, ProStar with 26" diameter tanks 1990 - 2016	
Position:		
Notes:	w/26" Diameter Tank, Includes gaskets and hardware	
OE Number:	3595189C1, 6111572C1, 3595189C2, 3864401C91	

Fuel Tank Strap 		578-5102
		
Make:	International	
Applications:	All International models with 50 and 60 gallon square tanks 1997 - 2011	
Position:		
Notes:	50 and 60 gallon square tanks	
OE Number:	471453C2	

Grille 		242-5107
		
Make:	International	
Applications:	3200, 4100, 4100 SBA, 4200, 4200LP, 4300, 4400, 4400LP, 7300, 7300 SFA, 7400, 8500, 8500 SBA, RXT 1990 - 2016	
Position:	Front	
Notes:	Chrome, Includes mounting clips	
OE Number:	3551015C98, 3551015C92, 3551015C95, 3551015C94, 3551015C97, 3551015C96, 3551015C91, 3551015C99, 3551015C93	

INTERNATIONAL

Headlight Adjusting Screw – Headlight Bezel

Headlight Adjusting Screw  **924-5104** 



Make:	International
Applications:	3800 CE, 9400, ProStar, S1723, S1724, S1753, S1754, S1800, S2100, S2155, S2276 1984 - 2009
Position:	
Notes:	
OE Number:	500565C91

Headlight Assembly **888-5101**



Make:	International
Applications:	Workstar 7300, Workstar 7400, Workstar 7500, WorkStar 7600, WorkStar 7700 2009 - 2011
Position:	Right
Notes:	Includes Bulbs
OE Number:	3605817C92

Headlight Assembly **888-5102**



Make:	International
Applications:	Workstar 7300, Workstar 7400, Workstar 7500, WorkStar 7600, WorkStar 7700 2009 - 2011
Position:	Left
Notes:	Includes Bulbs
OE Number:	3605816C92

Headlight Assembly **888-5103**



Make:	International
Applications:	5900, 5900i, 5900i SBA, 9200, 9200 SBA, 9200i SBA 1993 - 2014
Position:	Right
Notes:	Includes Bulbs
OE Number:	3502929C95, 3502929C93, 3502929C94, 3502929C91, 3502929C92

Headlight Assembly **888-5104**



Make:	International
Applications:	5900, 5900i, 5900i SBA, 9200, 9200 SBA, 9200i SBA 1993 - 2014
Position:	Left
Notes:	Includes Bulbs
OE Number:	3502928C92, 3502928C91, 3502928C94, 3502928C93, 3502928C95

Headlight Assembly **888-5105**



Make:	International
Applications:	4100, 4100 SBA, 4200, 4300, 4300LP, 4400, 4400LP, 8500, 8500 TranStar, 8600, 8600 SBA, 8600 TranStar, CE School Bus, CE Series 2002 - 2015
Position:	Right
Notes:	Includes Bulbs; w/Marker Light
OE Number:	3574388C93, 3574388C92, 3574388C94, 3574388C91, 4020384C91

Headlight Assembly **888-5106**



Make:	International
Applications:	4100, 4100 SBA, 4200, 4300, 4300LP, 4400, 4400LP, 8500, 8500 TranStar, 8600, 8600 SBA, 8600 TranStar, CE School Bus, CE Series 2002 - 2015
Position:	Left
Notes:	Includes Bulbs; w/Marker Light
OE Number:	4020383C91, 3574387C93, 3574387C92, 3574387C91, 3574387C94

Headlight Assembly **888-5107**



Make:	International
Applications:	ProStar 2009 - 2012
Position:	Right
Notes:	Includes Bulbs
OE Number:	3596016C93, 3596016C94

Headlight Assembly **888-5108**



Make:	International
Applications:	ProStar 2009 - 2012
Position:	Left
Notes:	Includes Bulbs
OE Number:	3596015C94, 3596015C93

Headlight Assembly  **888-5109**



Make:	International
Applications:	3300, 4400, 8600, 8600 SBA 2007 - 2011
Position:	Right
Notes:	Includes Bulbs; wo/Marker Light
OE Number:	3565430C92, 4020417C91, 3565430C93, 3565430C91

Headlight Assembly  **888-5110**



Make:	International
Applications:	3300, 4400, 8600, 8600 SBA 2007 - 2011
Position:	Left
Notes:	Includes Bulbs; wo/Marker Light
OE Number:	3565429C91, 3565429C93, 3565429C92, 4020416C91

Headlight Bezel  **888-5101**



Make:	International
Applications:	3800 CE, 4200, 4300, 4300LP, 4400, 4400LP, 4600, 4600LP, 4600UH, 4700, 4700LP, 4700LPX, 4800, 4900, 8000, 8100, 8200, 8300, 8500, 8500 SBA, 8600 SBA 1990 - 2004
Position:	Left
Notes:	Gray
OE Number:	EE02004024, 1661763C1, 1654293C1, 3000077C1, 34004277

INTERNATIONAL

Headlight Bezel – Instrument Panel Circuit Board

Headlight Bezel 		889-5102
		
Make:	International	
Applications:	3800 CE, 4200, 4300, 4300LP, 4400, 4400LP, 4600, 4600LP, 4600UH, 4700, 4700LP, 4700LPX, 4800, 4900, 8000, 8100, 8200, 8300, 8500, 8500 SBA, 8600 SBA 1990 - 2004	
Position:	Right	
Notes:	Gray	
OE Number:	1654294C1, 1661764C1, 3000078C1, EE02004023, 34004274	

Hood Hinge Spring 		938-5101 
		
Make:	International	
Applications:	3000, 3600, 3700, 3800, 3800 CE, 3900FC, 4600, 4600LP, 4600UH, 4700, 4700LP, 4700LPX, 4800, 4900, S1654, S1654LP, S1753, S1754, S1800, S1853, S1853FC, S1854, S1954, S1955, S2155, S2554 1989 - 2001	
Position:		
Notes:	Gold	
OE Number:	1675762C3	

Hood Hinge Spring		938-5102 
		
Make:	International	
Applications:	2554, 2574, 2654, 8000, 8500, 8500 TranStar, 8600, 8600 SBA, 8600 TranStar, 9600, 9700, 9900i, 9900i SFA, 9900ix, 9900ix SFA 1986 - 2011	
Position:		
Notes:	Gold, Long hook	
OE Number:	3588532C2	

Hood Hinge Spring		938-5103 
		
Make:	International	
Applications:	9200, 9200 SBA, 9200i SBA, 9400 1997 - 2009	
Position:		
Notes:	Gold; small	
OE Number:	598574C3	

Hood Latch Assembly 		315-5101 
		
Make:	International	
Applications:	14525C, 15525C, 16525C, 1652UPS, 4600, 4600LP, 4600UH, 4700, 4700LP, 4700LPX, 4800, 4900, 7100, 8000, 8500 TranStar, 8600 TranStar, M1400 Metro II, M1600 Metro II, S1654, S1654LP, S1723, S1724, S1753, S1754, S1800, S1823, S1824, S1853, S1853FC, S1854, S1 1980 - 2011	
Position:	Left; Right	
Notes:	Contains all brackets	
OE Number:	500273C2, 500271C1, 499523C3, 500274C1, 500269C1, 1689930C91, 500269A, 1699929C92, 1699929C91, 500270C1, 500273C1, 1699929C9, 1689930C9	

HVAC Heater Blend Door Actuator		604-5101
		
Make:	International	
Applications:	4200, 4300, 4400, 7400, 7500, 7600, 8500, 8600, 8600 SBA, LoneStar, ProStar 2001 - 2012	
Position:		
Notes:	For Main Cab Unit; Located Inside Cab; w/BEHR HVAC Unit, Mode; Located Inside Cab	
OE Number:	3542606C1, 2611234C1	



HVAC Heater Blend Door Actuator		604-5104
		
Make:	International	
Applications:	5500i, 5600i, 5900i, 5900i SBA, 9100i SBA, 9200i SBA, 9900i, 9900i SFA, 9900ix, 9900ix SFA, CV, CXN, CXP, Pinnacle, Vision 2000 - 2011	
Position:		
Notes:	4 Pin Connector; Label ID No. B3570874A, w/Bergstrom Air Conditioning; 4 Pin Connector; Label ID No. B3570874A	
OE Number:	651261, RD5146090P, 2115003, 2383, 100830, 7787650694, 2503207C1, MA1640, MA1705	

HVAC Heater Blend Door Actuator		604-5105
		
Make:	International	
Applications:	5500i, 5600, 5600i, 5900, 5900i, 5900i SBA, 9100i SBA, 9200, 9200i SBA, 9300, 9400, 9400i SBA, 9800, 9900i, 9900i SFA, 9900ix, 9900ix SFA 2001 - 2008	
Position:		
Notes:	4 Pin Connector; Label No. G32063211A	
OE Number:	2384, 100831, 3524465C1, 2113007, MA1720, 650625	

HVAC Heater Blend Door Actuator		604-5106
		
Make:	International	
Applications:	4200, 4300, 4400, 7400, 7500, 7600, 8500, 8600, 8600 SBA, C500, LoneStar, ProStar, T300, T600A, T800, W900 2001 - 2012	
Position:		
Notes:	Fresh/Recirculating Air; 2 Pin Connector, Fresh/Recirculating Air; For Main Cab Unit; 2 Pin Connector, Fresh/Recirculating Air; For Main Cab Unit; Located Outside Cab; 2 Pin Connector, Fresh/Recirculating Air; Located Outside Cab; 2 Pin Connector	
OE Number:	3542575C2, MA1710, 100833, 2386, 2113005, 3542575C1, 640059, RD5146100P	

HVAC Heater Blend Door Actuator		604-5107
		
Make:	International	
Applications:	LoneStar, ProStar 2008 - 2011	
Position:		
Notes:	For Sleeper Cab Unit; 5 Pin Connector; Label ID No. G1114	
OE Number:	RD5146080P, 2389, 3599602C1, 2113015, 100834	

HVAC Heater Water Shut-Off Valve Actuator 		604-5103
		
Make:	International	
Applications:	1988 - 2015	
Position:		
Notes:	4 Pin Connector; Label ID No. A35130293B	
OE Number:	ZGG717058, 2118004, H9635, 101432, 651258, MA1430, 2371, 2380, MA1360, 2370, 65034185M, 101032, ZGG717002, 3543H9635, 868505BSM, 1696831C1, ABPN833280, 2499080, 2392, ABPN833241, 2117005, 324165BSM, 71R3571, 3020965, MA0200015, 3947439, 00031247,	

Instrument Panel Circuit Board 		599-5103
		
Make:	International	
Applications:	2554, 2574, 2654, 2674, 3000, 3000 IC, 3000FE, 3000IC, 3000RE, 3400, 3600, 3700, 3800, 3800 CE, 3900, 3900FC, 4700, 4700LP, 4700LPX, 4800, 4900, 8100 1992 - 2002	
Position:		
Notes:	New not remanufactured, fits both electric and mechanical oil pressure gauges	
OE Number:	3595124C2, 3525091C91, 3525074C91, 3595124C1, 1689995C93, 1689996C93, 3525078C91, 2512565C91	

Interior Door Handle	761-5103
	
Make:	International
Applications:	Durastar 2010 - 2011
Position:	Front Right
Notes:	Black
OE Number:	2505425C1

Interior Door Handle	761-5104
	
Make:	International
Applications:	Durastar 2010 - 2011
Position:	Front Left
Notes:	Black
OE Number:	2505424C1

Interior Door Handle	761-5106
	
Make:	International
Applications:	5000, 5500i, 5600, 5600i, 5900, 5900i, 5900i SBA, 9100 SBA, 9100i SBA, 9200, 9200 SBA, 9200i SBA, 9300, 9400, 9400i SBA, 9600, 9700, 9800, 9800 SBA, 9800 SFA, 9900, 9900 SFA, 9900i, 9900i SFA, 9900ix, 9900ix SFA 1986 - 2015
Position:	Front Left
Notes:	Black
OE Number:	1649758C1, 02023003

Interior Door Handle	761-5107
	
Make:	International
Applications:	5000, 5500i, 5600, 5600i, 5900, 5900i, 5900i SBA, 9100 SBA, 9100i SBA, 9200, 9200 SBA, 9200i SBA, 9300, 9400, 9400i SBA, 9600, 9700, 9800, 9800 SBA, 9800 SFA, 9900, 9900 SFA, 9900i, 9900i SFA, 9900ix, 9900ix SFA 1986 - 2015
Position:	Front Right
Notes:	Black
OE Number:	1649759C1, 02023008

Interior Door Handle	761-5108
	
Make:	International
Applications:	5000, 5500i, 5600, 5600i, 5900, 5900i, 5900i SBA, 9100 SBA, 9100i SBA, 9200, 9200 SBA, 9200i SBA, 9300, 9400, 9400i SBA, 9600, 9700, 9800, 9800 SBA, 9800 SFA, 9900, 9900 SFA, 9900i, 9900i SFA, 9900ix, 9900ix SFA 1986 - 2015
Position:	Front Left
Notes:	Chrome
OE Number:	02023003, 1649758C1

Interior Door Handle	761-5109
	
Make:	International
Applications:	5000, 5500i, 5600, 5600i, 5900, 5900i, 5900i SBA, 9100 SBA, 9100i SBA, 9200, 9200 SBA, 9200i SBA, 9300, 9400, 9400i SBA, 9600, 9700, 9800, 9800 SBA, 9800 SFA, 9900, 9900 SFA, 9900i, 9900i SFA, 9900ix, 9900ix SFA 1986 - 2015
Position:	Front Right
Notes:	Chrome
OE Number:	1649759C1, 02023008

Interior Door Pull Handle	760-5109
	
Make:	International
Applications:	5000, 5500i, 5600, 5600i, 5900, 5900i, 5900i SBA, 9100i SBA, 9200, 9200i SBA, 9400, 9400i SBA, 9900, 9900i SFA, 9900ix SFA 2000 - 2015
Position:	
Notes:	Black, Textured
OE Number:	3518423C1

Interior Door Pull Handle	761-5105
	
Make:	International
Applications:	3200, 4100, 4200, 4200LP, 4300, 4300LP, 4400, 4400LP, 7300, 7300 SBA, 7300 SFA, 7400, 7500, 7600, 7700 2005 - 2011
Position:	Front Left; Front Right
Notes:	Gray
OE Number:	2505201C1

Manifold Absolute Pressure Sensor	904-7033
	
Make:	International
Applications:	Caterpillar C12 engines 2000 - 2000
Position:	Manifold
Notes:	
OE Number:	1946724, 1619929

Manifold Absolute Pressure Sensor	904-7037
	
Make:	International
Applications:	Caterpillar C11 engines 2003 - 2006
Position:	Manifold
Notes:	
OE Number:	2393478

Manifold Absolute Pressure Sensor	904-7107
	
Make:	International
Applications:	Cummins ISX 15 engines 2002 - 2006
Position:	Manifold
Notes:	
OE Number:	4928593

Manifold Absolute Pressure Sensor	904-7505
	
Make:	International
Applications:	VT365, DT530, T444E 1979 - 2016
Position:	Manifold
Notes:	
OE Number:	1840078C1

INTERNATIONAL

Manifold Absolute Pressure Sensor – Seat Cushion Pad

Manifold Absolute Pressure Sensor  **904-7525**



Make:	International
Applications:	VT365, DT466, DT530 1979 - 2016
Position:	Manifold
Notes:	
OE Number:	1839416C91

Manifold Absolute Pressure Sensor  **904-7532**





Make:	International
Applications:	VT365 1986 - 2016
Position:	Manifold
Notes:	
OE Number:	1846481C92

Manual Trans Shift Boot **924-5111** 



Make:	International
Applications:	2554, 2574, 2654, 2674, 4200, 4200LP, 4300, 4300LP, 4400, 4400LP, 4600, 4600LP, 4600UH, 4700, 4700LP, 4700LPX, 4800, 4900 1990 - 2004
Position:	
Notes:	
OE Number:	291068C2

Multi Function Switch  **978-5101**



Make:	International
Applications:	3000, 3000RE, 3200, 3300, 3400, 3600, 3800, 3800 CE, 4700, 4700LP, 4700LPX, 4800, 4900 1989 - 2010
Position:	
Notes:	Thomas School Buses Built On International Chassis
OE Number:	1669742C91, 2502912C91, 1685611C91, 1699742C91

Multi Function Switch **978-5102**



Make:	International
Applications:	9100i SBA, 9200, 9200i SBA, 9400, 9400i SBA, 9800, 9900, 9900i, 9900i SFA, 9900ix, 9900ix SFA 2002 - 2014
Position:	
Notes:	Black
OE Number:	3544933C92, 999392

Power Window Motor and Regulator Assembly **741-5101**



Make:	International
Applications:	Universal 2003 - 2011
Position:	Front Right
Notes:	Power Window Regulator w/Motor, Power Window Regulator w/Motor; Exc. School Bus
OE Number:	3515113C92

Power Window Motor and Regulator Assembly **741-5102**



Make:	International
Applications:	Universal 2003 - 2011
Position:	Front Left
Notes:	Power Window Regulator w/Motor, Power Window Regulator w/Motor; Exc. School Bus
OE Number:	3515112C92

Roof Marker Light  **888-5125**



Make:	International
Applications:	4200, 4200LP, 4300, 4300LP, 4400, 4400LP, 5600, 5600i, 5900, 5900i, 7300, 7300 SBA, 7300 SFA, 7400, 7500, 7600, 8600, 9200, 9200 SBA, 9200i SBA, 9400, 9400i SBA, 9800, 9800 SBA, 9800 SFA, 9900, 9900 SFA, 9900i, 9900i SFA, 9900ix, 9900ix SFA, BE, CE, Lonestar 1986 - 2016
Position:	
Notes:	Amber
OE Number:	3529900C97

Seat Cushion Pad **641-5101**



Make:	International
Applications:	3200, 4100, 4100 SBA, 4200, 4200LP, 4300, 4300LP, 4400, 4400LP, 7300, 7300 SBA, 7300 SFA, 7400, 7500, 7600, 7700, 8500, 8500 SBA, 8500 TranStar, 8600, 8600 SBA, 8600 TranStar, TerraStar 2001 - 2016
Position:	
Notes:	Charcoal; Cloth/Vinyl; w/National Seats
OE Number:	2595485C92

Seat Cushion Pad **641-5102**



Make:	International
Applications:	3000, 3000IC, 3000RE, 4100, 4100 SBA, 4200, 4200LP, 4300, 4300LP, 4400, 4400LP, 7300, 7300 SBA, 7300 SFA, 7400, 7500, 7600, 7700, 8500, 8500 SBA, 8500 TranStar, 8600, 8600 SBA, 8600 TranStar, TerraStar 2001 - 2016
Position:	
Notes:	Gray; Vinyl; w/National Seats
OE Number:	2505891C92

Seat Cushion Pad **641-5104**



Make:	International
Applications:	3200 2007 - 2007
Position:	
Notes:	Gray; Cloth/Vinyl; w/National Seats
OE Number:	2505895C92

Seat Cushion Pad **641-5106**



Make:	International
Applications:	3000, 3000IC, 3000RE, 4100, 4100 SBA, 4200, 4200LP, 4300, 4300LP, 4400, 4400LP, 7300, 7300 SBA, 7300 SFA, 7400, 7500, 7600, 7700, 8500, 8500 SBA, 8500 TranStar, 8600, 8600 SBA, 8600 TranStar, TerraStar 2001 - 2016
Position:	
Notes:	Charcoal; Vinyl; w/National Seats
OE Number:	2594999C92

INTERNATIONAL

Seat Cushion Pad – Turbocharger Boost Sensor

Seat Cushion Pad **641-5107**



Make:	International
Applications:	5500i, 5600, 5600i, 5900, 5900i, 5900i SBA, 9100 SBA, 9100i SBA, 9200, 9200 SBA, 9200i SBA, 9400, 9400i SBA, 9900, 9900 SFA, 9900i, 9900i SFA, 9900ix, 9900ix SFA 1986 - 2015
Position:	
Notes:	Tan, Cloth, w/National Seats
OE Number:	2509550C92

Seat Cushion Pad **641-5109**



Make:	International
Applications:	7300, 7300 SBA, 7300 SFA, ProStar 2001 - 2016
Position:	
Notes:	Charcoal; Cloth; w/National Seats
OE Number:	2607246C91

Sensor - Auto Transmission Speed **904-7026**



Make:	International
Applications:	Caterpillar C11 engines 2004 - 2006
Position:	Input
Notes:	
OE Number:	2016616

Truck Cab Side Step **157-5101**



Make:	International
Applications:	1300, 1300A, 1300B, 1300C, 1300D, 1310, 1310M, 3200, 3800, 4100, 4100 SBA, 4200, 4200LP, 4300, 4300LP, 4400, 4400LP, 7300, 7300 SBA, 7300 SFA, 7400, 7500, 7600, 7700, 8500, 8500 SBA, 8500 TranStar, 8600, 8600 SBA, 8600 TranStar, CXT, RXT 1966 - 2014
Position:	
Notes:	32.75 In. Long x 8 In. Wide, Direct fit, Black
OE Number:	3536371C1, 3536371C2

Truck Cab Side Step **157-5102**



Make:	International
Applications:	3200, 4300, 4400, 7300, 7300 SBA, 7400, 7500, 7600, 7700, 8500, 8600, RXT, TerraStar 2001 - 2013
Position:	
Notes:	35.25 In. Long x 6 In. Wide, Direct fit, Black
OE Number:	3571060C1

Truck Cab Side Step **157-5103**



Make:	International
Applications:	ProStar 2009 - 2012
Position:	
Notes:	36 In. Long x 6.8 In. Wide, Fits Base and Premium Models, Direct fit, matching finish
OE Number:	3808858C2

Truck Cab Side Step **157-5104**



Make:	International
Applications:	1300, 3200, 3800, 3800 CE, 7300, 7300 SBA, 7300 SFA, 7400, 7500, 7600, 7700, 8500, 8500 SBA, 8500 TranStar, 8600, 8600 SBA, 8600 TranStar 1997 - 2014
Position:	
Notes:	32.75 In. Long x 5 In. Wide, Lower, Direct fit, Black
OE Number:	3578201C1

Truck Cab Side Step **157-5106**



Make:	International
Applications:	1300, 3200, 3800, 3800 CE, 4100, 4100 SBA, 4200, 4200LP, 4300, 4300LP, 4400, 7300, 7300 SBA, 7300 SFA, 7400, 7500, 7600, 7700, 8500, 8500 SBA, 8500 TranStar, 8600, 8600 SBA, 8600 TranStar 1997 - 2014
Position:	
Notes:	27.75 In. Long x 5 In. Wide, Upper, Direct fit, Black
OE Number:	3578200C1

Truck Cab Side Step **157-5111**



Make:	International
Applications:	3200, 4300, 4300LP, 4400, 4400LP, 7300, 7300 SBA, 7300 SFA, 7400, 7500, 7600, 8500, 8500 SBA, 8500 TranStar, 8600, 8600 SBA, 8600 TranStar, ProStar 2001 - 2014
Position:	
Notes:	17.8 In. Long x 5 In. Wide, Black
OE Number:	3589481C1

Turbocharger Boost Pressure Valve **599-5001**



Make:	International
Applications:	Cummins ISM 10.8, ISX 15 2005 - 2007
Position:	
Notes:	Remanufactured
OE Number:	3770742, 4037440, 4039813, 4046304, 2836554, 4040589, 4036195

Turbocharger Boost Sensor **904-7015**



Make:	International
Applications:	Caterpillar 3126 engines 1995 - 1996
Position:	
Notes:	Outlet
OE Number:	1619927, 1414120, 3E6379, 1112351, 1212728

Turbocharger Boost Sensor **904-7028**



Make:	International
Applications:	Caterpillar 3126 engines 1997 - 1998
Position:	
Notes:	Inlet
OE Number:	1414119, 1946722, 1619925

INTERNATIONAL

Turbocharger Speed Sensor – Window Crank Handle

Turbocharger Speed Sensor 904-7111



Make:	International
Applications:	Cummins ISX 11.9, ISX 15 2010 - 2011
Position:	
Notes:	2010 EPA Standard
OE Number:	4032173

Turbocharger Speed Sensor  904-7146



Make:	International
Applications:	ISB 200, ISB 6.7, ISB6.7, ISB6.7-200, ISB6.7-220, ISB6.7-240, ISB6.7-260, ISB6.7-280 2011 - 2016
Position:	
Notes:	
OE Number:	4032806

Turn Signal / Side Marker Light Assembly 888-5112



Make:	International
Applications:	3000, 3000FE, 3000IC, 3000RE, 3600, 3800, 4700, 4700LP, 4700LPX, 4800, 4900, 8100 1990 - 2002
Position:	Front Left
Notes:	Amber
OE Number:	1661761C93

Turn Signal / Side Marker Light Assembly 888-5113



Make:	International
Applications:	3000, 3000FE, 3000IC, 3000RE, 3600, 3800, 4700, 4700LP, 4700LPX, 4800, 4900, 8100 1990 - 2002
Position:	Front Right
Notes:	Amber
OE Number:	1661762C93

Turn Signal / Side Marker Light Assembly 888-5120



Make:	International
Applications:	5900, 5900i, 5900i SBA, 9200, 9200 SBA, 9200i SBA 1994 - 2008
Position:	Front Right
Notes:	Lens only
OE Number:	2505369C91

Turn Signal / Side Marker Light Assembly 888-5121



Make:	International
Applications:	5900, 5900i, 5900i SBA, 9200, 9200 SBA, 9200i SBA 1994 - 2008
Position:	Front Left
Notes:	Lens only
OE Number:	2505366C91

Turn Signal / Side Marker Light Assembly 888-5122





Make:	International
Applications:	3200, 3300, 4100, 4100 SBA, 4200, 4200LP, 4300, 4300LP, 4400, 4400LP, 7300, 7300 SBA, 7300 SFA, 7400, 7500, 8500, Durastar, RXT 2001 - 2014
Position:	Front Right
Notes:	Hood Mounted
OE Number:	3561966C1

Turn Signal / Side Marker Light Assembly 888-5123





Make:	International
Applications:	3200, 3300, 4100, 4100 SBA, 4200, 4200LP, 4300, 4300LP, 4400, 4400LP, 7300, 7300 SBA, 7300 SFA, 7400, 7500, 8500, Durastar, RXT 2001 - 2014
Position:	Front Left
Notes:	Hood Mounted
OE Number:	3561965C1

Vehicle Speed Sensor 505-5104 



Make:	International
Applications:	9600, 9700 1990 - 1996
Position:	
Notes:	
OE Number:	2503117C1

Vehicle Speed Sensor 505-5105 



Make:	International
Applications:	1552SC, 1652SC, 4100, 4100 SBA, 4200, 4200LP, 4300, 4300LP, 4400, 4400LP, 4700, 4700LP, 4700LPX, 4800, 4900, 5500i, 5600, 5900i SBA, 7300, 7300 SBA, 7300 SFA, 7400, 7500, 7600, 7700, 8000, 8100, 8200, 8500, 8600 SBA, 9100 SBA, 9100i SBA, 9200, 9200 SBA, 1997 - 2007
Position:	
Notes:	
OE Number:	3528003C1

Washer Fluid Reservoir  603-5102



Make:	International
Applications:	3000, 3000RE, 3200, 3300, 4700, 4700LP, 4700LPX, 4800, 4900 1997 - 2007
Position:	
Notes:	Includes caps, pump, and level sensors (where applicable)
OE Number:	2033902C92, 2033902C91, 2033903C92

Window Crank Handle 775-5101 



Make:	International
Applications:	4300, 4300LP, Durastar 2002 - 2009
Position:	Left; Right
Notes:	Black Handle; w/Black Knob
OE Number:	3508990C4

INTERNATIONAL

Window Crank Handle – Windshield Washer Nozzle

Window Crank Handle **775-5102**



Make:	International
Applications:	1652SC, 1652UPS, 2554, 2654, 3000, 3000RE, 4600, 4600LP, 4600UH, 4700, 4700LP, 4700LPX, 4800, 4900, 5000, 7100, 8000, 9100 SBA, 9100i SBA 1984 - 2005
Position:	
Notes:	Black
OE Number:	1649776C1

Window Crank Handle **775-5104**



Make:	International
Applications:	1600, 1600 4WD, 1600 Binder, 1600 Loadstar, 1652UPS, 2554, 2574, 2575, 2654, 2674, 2675, 3000, 3400, 3600, 3700, 3800, 3900 1962 - 2014
Position:	
Notes:	Chrome
OE Number:	1649776C1

Window Regulator **740-5103**



Make:	International
Applications:	1452 FC, 1452SC, 1652SC, 1652UPS, 2554, 2574, 2575, 2654, 2674, 2675, 3000, 4600, 4600LP, 4600UH, 4700, 4700LP, 4700LPX, 4800, 4900, 7100, 8100, 8200, 8300, 9600, 9700, 9800, 9800 SBA, 9800 SFA 1989 - 2002
Position:	Front Right
Notes:	Manual
OE Number:	1686705C91

Window Regulator **740-5104**



Make:	International
Applications:	1452 FC, 1452SC, 1652SC, 1652UPS, 2554, 2574, 2575, 2654, 2674, 2675, 3000, 4600, 4600LP, 4600UH, 4700, 4700LP, 4700LPX, 4800, 4900, 7100, 8100, 8200, 8300, 9600, 9700, 9800, 9800 SBA, 9800 SFA 1989 - 2002
Position:	Front Left
Notes:	Manual
OE Number:	1686704C91

Windshield Washer Nozzle **924-5101**



Make:	International
Applications:	3000, 3000RE, 3200, 3300, 3300 CE, 3400, 3600, 3800, 3800 CE, 4100, 4200, 4200LP, 4300, 4300LP, 4400, 4400LP, 4700, 4700LP, 4700LPX, 4800, 4900, 7300, 7400, 7500, 7600, 7700, 8000, 8500, 8500 TranStar, 8600, 8600 SBA, 8600 TranStar, 9200, 9200i SBA 2001 - 2015
Position:	Front
Notes:	Includes washer hose and nozzle
OE Number:	1696499C1

HD RESERVOIRS

The Aftermarket's Most Comprehensive Fluid Reservoir Coverage

- Avoid CSA points by replacing cracked or leaking reservoirs
- Dorman HD Reservoirs are engineered with a clear design eliminating need for leak prone sight gauges



603-5505
Volvo D12 2015-08

603-5104
International 4200, 4300, 4400 2011-03

603-5504
Volvo D12 2007-97

DORMAN CSA COMPLIANCE
DORMAN OE FIX

KENWORTH

Dashboard Air Vent – Door Mirror Cover

Dashboard Air Vent 216-5401



Make:	Kenworth
Applications:	C500, W900 1982 - 2005
Position:	Left
Notes:	Fits 2 In. x 5 In. Dash Opening, Black
OE Number:	S451006

Dashboard Air Vent 216-5402



Make:	Kenworth
Applications:	C500, W900 1982 - 2005
Position:	Right
Notes:	Fits 2 In. x 5 In. Dash Opening, Black
OE Number:	S451007

Dashboard Air Vent 216-5403



Make:	Kenworth
Applications:	C500, W900 1982 - 2005
Position:	Center
Notes:	Fits 2 In. x 5 In. Dash Opening, Black
OE Number:	S451005

Dashboard Air Vent 216-5406



Make:	Kenworth
Applications:	W900 2006 - 2012
Position:	Center, Left, Right
Notes:	Black
OE Number:	S451020

Diesel Emissions Fluid Filler Cap 904-5401



Make:	Kenworth
Applications:	C500, T2000, T660, T800, W900 2010 - 2012
Position:	
Notes:	
OE Number:	908022301

Diesel Particulate Filter Clamp 674-9000



Make:	Kenworth
Applications:	Cummins ISX Engines 2007 - 2015
Position:	
Notes:	w/2007 & 2010 EPA Standards, Includes gaskets and hardware
OE Number:	21445455

Differential Oil Temperature Sensor 505-5401



Make:	Kenworth
Applications:	T600A, T660, T800 1987 - 2007
Position:	
Notes:	
OE Number:	Q211002

Door Mirror Cover 955-5401



Make:	Kenworth
Applications:	T600, T600A, T660 1990 - 2015
Position:	Right
Notes:	Black
OE Number:	R59101021

Door Mirror Cover 955-5402



Make:	Kenworth
Applications:	T600, T600A, T660 1990 - 2015
Position:	Right
Notes:	Chrome
OE Number:	R59101022

Door Mirror Cover 955-5403



Make:	Kenworth
Applications:	T600, T600A, T660 1990 - 2015
Position:	Left
Notes:	Black
OE Number:	R59101921

Door Mirror Cover 955-5404



Make:	Kenworth
Applications:	T600, T600A, T660 1990 - 2015
Position:	Left
Notes:	Chrome
OE Number:	R59101922

Door Mirror Cover 955-5405



Make:	Kenworth
Applications:	T2000 1997 - 2011
Position:	Right
Notes:	Black
OE Number:	R59101011

Door Mirror Cover 955-5406



Make:	Kenworth
Applications:	T2000 1997 - 2011
Position:	Right
Notes:	Chrome
OE Number:	R59101012

Door Mirror Cover 955-5407



Make:	Kenworth
Applications:	T2000 1997 - 2011
Position:	Left
Notes:	Black
OE Number:	R59101911

Door Mirror Cover 955-5408



Make:	Kenworth
Applications:	T2000 1997 - 2011
Position:	Left
Notes:	Chrome
OE Number:	R59101912

Door Mirror Switch 901-5401



Make:	Kenworth
Applications:	T660 2006 - 2010
Position:	
Notes:	Gray w/ Black buttons
OE Number:	P271098001

EGR Cooler 904-5035



Make:	Kenworth
Applications:	Cummins ISX 15 2003 - 2007
Position:	
Notes:	Includes all gaskets and hardware
OE Number:	2881783, 3682986, 4089436, 3683435, 4952490, 4956008NX, 4089166, 4956008, 2881783NX, 3683253, 2878071, 3683069, 2869133, 3682806

EGR Cooler 904-5036



Make:	Kenworth
Applications:	Cummins ISM 2003 - 2007
Position:	
Notes:	Includes all gaskets and hardware
OE Number:	4089380, 3102803, 4089380NX

EGR Cooler Gasket Kit 904-5007



Make:	Kenworth
Applications:	Cummins Gen 1 ISX 15.0, ISX 15.0, CL700 SubModel, ISX-400, ISX-450, ISX-475, ISX-500, ISX-565, ISX-600 2003 - 2007
Position:	
Notes:	Includes all gaskets and hardware
OE Number:	4309434NX

EGR Cooler Gasket Kit 904-5008



Make:	Kenworth
Applications:	ISX 15.0, ISX-400, ISX-450, ISX-475, ISX-500, ISX-565, ISX-600 2007 - 2010
Position:	
Notes:	Generation 2, Includes all gaskets and hardware
OE Number:	2881784, 4309398, 4309248, 4309248NX, 4955467, 3684448, 2881747, 2881784NX, 2881747NX, 4955926, 4309398NX

EGR Cooler Gasket Kit 904-5009



Make:	Kenworth
Applications:	Cummins ISX 11.9, ISX 15 2010 - 2011
Position:	
Notes:	Includes all gaskets and hardware
OE Number:	4309491NX

EGR Valve 904-5001



Make:	Kenworth
Applications:	Cummins ISX 2003 - 2007
Position:	
Notes:	Fits Engines Manufactured From 09/31/2002, Generation 1, Includes all gaskets and mounting hardware
OE Number:	4955422RX, 3683305, 3682974, 3682954, 3104874, 3682805, 4955422, 4955422NX, 3684004, 3683446

EGR Valve 904-5002



Make:	Kenworth
Applications:	Cummins ISM 2003 - 2007
Position:	
Notes:	Fits Engines Manufactured From 09/31/2002, Generation 1, Includes all gaskets and mounting hardware
OE Number:	4921905, 3104875, 4955421, 3103765, 4955421RX, 3103824, 3103361, 2102745

Engine Camshaft Position Sensor 904-7017



Make:	Kenworth
Applications:	Caterpillar C15 engines 2004 - 2005
Position:	Center Upper
Notes:	
OE Number:	2016617

KENWORTH

Engine Camshaft Position Sensor – Engine Oil Drain Plug

Engine Camshaft Position Sensor 904-7129



Make:	Kenworth
Applications:	Cummins ISB 1998-2001
Position:	
Notes:	
OE Number:	4921597

Engine Coolant Pipe 936-5403



Make:	Kenworth
Applications:	Caterpillar 3176, C15 1990 - 2009
Position:	Lower
Notes:	Tube With 4 Bolt Flange; Includes Gasket, Stainless
OE Number:	K1815141

Engine Coolant Pipe 936-5404



Make:	Kenworth
Applications:	Caterpillar C15 2004 - 2009
Position:	Lower
Notes:	Stainless
OE Number:	K1815483

Engine Coolant Pipe 936-5405



Make:	Kenworth
Applications:	Caterpillar C15 2003 - 2009
Position:	Lower
Notes:	Stainless, Tube With 2 Slip Ends
OE Number:	K1815597

Engine Coolant Reservoir 603-5403



Make:	Kenworth
Applications:	T2000, T660 1997 - 2015
Position:	
Notes:	Includes caps, pump, and level sensors (where applicable), w/ BEHR cooling module
OE Number:	N5346001

Engine Coolant Reservoir Cap 902-5403



Make:	Kenworth
Applications:	T660, T800, W900 2008 - 2010
Position:	
Notes:	wo/Hose Nipple(s)
OE Number:	RC0050

Engine Coolant Temperature Sensor 904-7039



Make:	Kenworth
Applications:	Caterpillar 3406 engines 1994 - 1997
Position:	
Notes:	
OE Number:	1022240

Engine Crankshaft Position Sensor 904-7020



Make:	Kenworth
Applications:	Caterpillar 3126BTA6 engines 2002 - 2003
Position:	Rear Left Rearward
Notes:	
OE Number:	1693300, 1194142, 2454630

Engine Crankshaft Position Sensor 904-7021



Make:	Kenworth
Applications:	Caterpillar C11 engines 2004 - 2006
Position:	Rear Left
Notes:	
OE Number:	2016615

Engine Crankshaft Position Sensor 904-7123



Make:	Kenworth
Applications:	Cummins ISB 5.9 1998 - 2001
Position:	Front
Notes:	
OE Number:	4921601

Engine Mount 917-5401



Make:	Kenworth
Applications:	CS00, T2000, T600A, T800 2003 - 2010
Position:	Rear
Notes:	Rebound Bushing
OE Number:	K066421

Engine Oil Drain Plug 090-5001



Make:	Kenworth
Applications:	Caterpillar 3176, C10, C11, C12, C13, 1989 - 2013
Position:	
Notes:	
OE Number:	9X6451

Engine Oil Drain Plug 090-5002



Make:	Kenworth
Applications:	Cummins ISL, L10 engines 1974 - 2014
Position:	
Notes:	
OE Number:	3055069

Engine Oil Drain Plug 090-5003



Make:	Kenworth
Applications:	Cummins ISX 11.9, ISX 11.9G, ISX 15.0 1998 - 2015
Position:	
Notes:	
OE Number:	4926565

Engine Oil Drain Plug 090-5004



Make:	Kenworth
Applications:	Detroit Diesel Series 60 Engines 1987 - 2015
Position:	
Notes:	
OE Number:	23505720

Engine Oil Drain Plug Gasket 095-5001



Make:	Kenworth
Applications:	Caterpillar 3176, C10, C11, C12, C13 engines 1989 - 2013
Position:	
Notes:	
OE Number:	619458

Engine Oil Drain Plug Gasket 095-5002



Make:	Kenworth
Applications:	Cummins ISL, L10 Engines 1981 - 2010
Position:	
Notes:	
OE Number:	67946

Engine Oil Drain Plug Gasket 095-5003



Make:	Kenworth
Applications:	Cummins ISX 11.9, ISX 15.0 1998 - 2015
Position:	
Notes:	
OE Number:	3678606

Engine Oil Pressure Sensor 904-5050



Make:	Kenworth
Applications:	Cummins ISX 11.9, ISX 11.9G, ISX 15.0, ISX 2004 - 2016
Position:	
Notes:	
OE Number:	4921517

Engine Oil Pressure Sensor 904-7012



Make:	Kenworth
Applications:	Caterpillar 3126 engines 1999 - 2000
Position:	
Notes:	
OE Number:	2244536, 1946726

Engine Oil Pressure Sensor 904-7016



Make:	Kenworth
Applications:	Caterpillar C10 engines 1998 - 1999
Position:	
Notes:	
OE Number:	1619930, 3E7570, 1112350

Engine Oil Pressure Sensor 904-7027



Make:	Kenworth
Applications:	Caterpillar C15 engines 2004 - 2005
Position:	
Notes:	
OE Number:	1946725

Engine Oil Pressure Sensor 904-7109



Make:	Kenworth
Applications:	Cummins ISX engines 2000 - 2003
Position:	
Notes:	
OE Number:	4921475

Engine Oil Pressure Sensor 904-7241



Make:	Kenworth
Applications:	Cummins ISM 10.8 engines 2000 - 2002
Position:	
Notes:	
OE Number:	4921477

KENWORTH

Exhaust Manifold – Fuel Tank Sending Unit

Exhaust Manifold	674-5002
	
Make:	Kenworth
Applications:	Caterpillar C16 engines 2001 - 2004
Position:	
Notes:	
OE Number:	1501914, CT1333359

Exterior Door Handle	760-5403
	
Make:	Kenworth
Applications:	T270, T300, T370, T600, T600A, W900 2006 - 2016
Position:	Front Left
Notes:	Black; Chrome Handle,wo/Vent Window
OE Number:	R561025

Exterior Door Handle	760-5404
	
Make:	Kenworth
Applications:	T300, T800 1995 - 2002
Position:	Front Left
Notes:	Chrome, wo/Vent Window
OE Number:	K294411PAK

Exterior Door Handle	760-5405
	
Make:	Kenworth
Applications:	T300, T800 1995 - 2002
Position:	Front Right
Notes:	Chrome, wo/Vent Window
OE Number:	K294411RPA

Exterior Door Handle	760-5408
	
Make:	Kenworth
Applications:	T270, T300, T370, T600, T600A, W900 2006 - 2016
Position:	Front Right
Notes:	Black; Chrome Handle, wo/Vent Window
OE Number:	R561025R

Exterior Door Handle	760-5411
	
Make:	Kenworth
Applications:	T600, T600A, T800, W900 1981 - 2006
Position:	Front Right
Notes:	Chrome; w/Vent Window
OE Number:	K294321, K294194R

Exterior Door Handle	760-5412
	
Make:	Kenworth
Applications:	T600, T600A, T800, W900 1981 - 2006
Position:	Front Left
Notes:	Chrome; w/Vent Window
OE Number:	K294194

Fog Light	888-5414
	
Make:	Kenworth
Applications:	T660 2008 - 2015
Position:	Front, Left or Right
Notes:	Includes Bulb
OE Number:	P541062100

Fuel Pressure Sensor	904-7018
	
Make:	Kenworth
Applications:	Caterpillar C15 engines 2006 - 2008
Position:	
Notes:	
OE Number:	2842728, 2482168

Fuel Pressure Sensor	904-7029
	
Make:	Kenworth
Applications:	Caterpillar C7 engines 2005 - 2007
Position:	
Notes:	
OE Number:	2482169

Fuel Tank Sending Unit	285-5404
	
Make:	Kenworth
Applications:	T170, T2000, T270, T300, T370, T400, T450, T600A, T660, T800, W900 1987 - 2011
Position:	
Notes:	Direct Fit; 24.5 In. Diameter Fuel Tank; w/Harness, Includes gasket and hardware
OE Number:	5549137142, 5549107142, Q211043622, Q211024622

Fuel Tank Sending Unit	285-5405
	
Make:	Kenworth
Applications:	T170, T2000, T270, T300, T370, T400, T450, T600A, T660, T800, W900 1987 - 2011
Position:	
Notes:	Direct Fit; 22.5 In. Diameter Fuel Tank, Includes gasket and hardware
OE Number:	5549107142, 5549137142, Q211024559

Fuel Tank Sending Unit 285-5406



Make:	Kenworth
Applications:	T170, T2000, T270, T300, T370, T400, T450, T600A, T660, T800, W900 1987 - 2011
Position:	
Notes:	Direct Fit; 24.5 In. Diameter Fuel Tank; wo/Harness, Includes gasket and hardware
OE Number:	Q211043622

Fuel Tank Strap 578-5401



Make:	Kenworth
Applications:	13-210, 22-210, 548, 750, 849-S, 850, 950, ATX, C500, K100, K100E, K130, K150, K200, K220, K260, K270, K300, K360, K370, LW924, T170, T2000, T270, T300, T370, T400, T440, T450, T600A, T660, T700, T800, W900 1987 - 2011
Position:	
Notes:	22.5 In Diameter Tank
OE Number:	K841013002

Fuel Tank Strap 578-5402



Make:	Kenworth
Applications:	13-210, 22-210, 548, 750, 849-S, 850, 950, ATX, C500, K100, K100E, K130, K150, K200, K220, K260, K270, K300, K360, K370, LW924, T170, T2000, T270, T300, T370, T400, T440, T450, T600A, T660, T700, T800, W900 1987 - 2011
Position:	
Notes:	24.5 In. Diameter Tank w/Step
OE Number:	K841013005

Fuel Tank Strap 578-5403



Make:	Kenworth
Applications:	13-210, 22-210, 548, 750, 849-S, 850, 950, ATX, C500, K100, K100E, K130, K150, K200, K220, K260, K270, K300, K360, K370, LW924, T170, T2000, T270, T300, T370, T400, T440, T450, T600A, T660, T700, T800, W900 1987 - 2011
Position:	
Notes:	24.5 In. Diameter Tank w/Polished Step
OE Number:	K841013005

Fuel Tank Strap 578-5404



Make:	Kenworth
Applications:	13-210, 22-210, 548, 750, 849-S, 850, 950, ATX, C500, K100, K100E, K130, K150, K200, K220, K260, K270, K300, K360, K370, LW924, T170, T2000, T270, T300, T370, T400, T440, T450, T600A, T660, T700, T800, W900 1987 - 2011
Position:	
Notes:	24.5 In. Diameter Tank wo/Step
OE Number:	K841013006

Fuel Tank Strap 578-5405



Make:	Kenworth
Applications:	13-210, 22-210, 548, 750, 849-S, 850, 950, ATX, C500, K100, K100E, K130, K150, K200, K220, K260, K270, K300, K360, K370, LW924, T170, T2000, T270, T300, T370, T400, T440, T450, T600A, T660, T700, T800, W900 1987 - 2011
Position:	
Notes:	24.5 In. Diameter Tank w/3 In. Boss Plate
OE Number:	K841013008

Headlight Bezel 889-5405



Make:	Kenworth
Applications:	T300 2004 - 2007
Position:	Right
Notes:	Chrome
OE Number:	L181002R

Headlight Bezel 889-5406



Make:	Kenworth
Applications:	T300 2004 - 2007
Position:	Left
Notes:	Chrome
OE Number:	L181002

Hood Hinge Spring 938-5401



Make:	Kenworth
Applications:	W900 2003 - 2010
Position:	
Notes:	w/Fiberglass hood; White
OE Number:	L711002

Hood Hinge Spring 938-5402



Make:	Kenworth
Applications:	T2000, T300, T600A, T800, W900 1998 - 2010
Position:	
Notes:	Yellow
OE Number:	K22495

Hood Hinge Spring 938-5403



Make:	Kenworth
Applications:	C500, T800, W900 2003 - 2006
Position:	
Notes:	Blue
OE Number:	K22486

Hood Hinge Spring 938-5404



Make:	Kenworth
Applications:	C500, W900 2003 - 2006
Position:	
Notes:	Black
OE Number:	K22435

KENWORTH

Hood Hinge Spring – Interior Door Handle

Hood Hinge Spring	938-5405
	
Make:	Kenworth
Applications:	W900 2003 - 2010
Position:	
Notes:	w/Metton hood; Brown
OE Number:	L711004

Hood Hinge Spring	938-5408
	
Make:	Kenworth
Applications:	T600A, T800, W900 2003 - 2006
Position:	
Notes:	Red
OE Number:	K22481

Hood Latch Assembly	315-5401
	
Make:	Kenworth
Applications:	T300, T600A, T800, W900 1987 - 2010
Position:	Left; Right
Notes:	Exc. Ball Style, Contains all brackets
OE Number:	63011005, 63011005A, 2313857, L560001

Hood Latch Assembly	315-5402
	
Make:	Kenworth
Applications:	T600A, T800, W900 1985 - 2005
Position:	Left; Right
Notes:	Ball Style, Contains all brackets
OE Number:	K147107

Hood Pin	924-5410
	
Make:	Kenworth
Applications:	T2000, T600A, T800, W900 2003 - 2010
Position:	
Notes:	w/Pin Only
OE Number:	K179528

HVAC Heater Blend Door Actuator	604-5106
	
Make:	Kenworth
Applications:	T300, T600A, T800, W900 2001 - 2012
Position:	
Notes:	Fresh/Recirculating Air; 2 Pin Connector, Fresh/Recirculating Air; For Main Cab Unit; 2 Pin Connector, Fresh/Recirculating Air; For Main Cab Unit; Located Outside Cab; 2 Pin Connector, Fresh/Recirculating Air; Located Outside Cab; 2 Pin Connector
OE Number:	3542575C2, S20950, MA1710, 100833, 2386, 2113005, 3542575C1, 640059, RD5146100P

HVAC Heater Control Knob	702-5402
	
Make:	Kenworth
Applications:	T1170, T2000, T270, T300, T370, T600A, T660, T800, W900 2003 - 2009
Position:	
Notes:	Bergstrom HVAC System
OE Number:	FD1240

HVAC Heater Control Valve Actuator	604-5401
	
Make:	Kenworth
Applications:	T600A, T800, W900 2005 - 2011
Position:	
Notes:	5-Pin Connector
OE Number:	MA19000

HVAC Heater Water Shut-Off Valve Actuator	604-5103
	
Make:	Kenworth
Applications:	1988 - 2015
Position:	
Notes:	4 Pin Connector; Label ID No. A35130293B
OE Number:	ZGG717058, 2118004, H9635, 101432, 651258, MA1430, 2371, S21331, 2380, MA1360, 2370, 650341B5M, 101032, ZGG717002, 3543H9635, 868505B5M, 1696831C1, ABPN833280, 2499080, 2392, ABPN833241, 2117005, 324165B5M, 71R3571, 3020965, MA0200015, 3947439, 00031247,

HVAC Heater Water Shut-Off Valve Actuator	604-5103
	
Make:	Kenworth
Applications:	1988 - 2015
Position:	
Notes:	4 Pin Connector, 4 Pin Connector; For Sleeper Cab Unit, 4 Pin Connector; Label No A35130293A
OE Number:	104305, 101632, 641030, 651273, 651259, 317700, 3947430, 2199011, ABPN833011, DA1040, 2199066, 2199069, 71R3575, 3020965, MA1685, RD563200, SX012834, 3685800C1, MA0200015, 00031247, RD563200P, 00090191, 00063495, 71R3571, 3947439, 101032, H9635, ZGG71705

HVAC Heater Water Shut-Off Valve Actuator	604-5112
	
Make:	Kenworth
Applications:	T600A, T800, W900 2005 - 2011
Position:	
Notes:	5-Pin Connector
OE Number:	2499082, 101437, 2397, ZGG717062, 870731B5M, 870731, BSM870731, 1000192487, 1515

Interior Door Handle	760-5423
	
Make:	Kenworth
Applications:	T400, T450, T600, T600A, T800, W900 1982 - 2005
Position:	Front Right
Notes:	Chrome, w/Vent Window
OE Number:	K294195R

Interior Door Handle 760-5424



Make:	Kenworth
Applications:	T400, T450, T600, T600A, T800, W900 1982 - 2005
Position:	Front Left
Notes:	Chrome, w/Vent Window
OE Number:	K294195

Interior Door Handle 761-5406



Make:	Kenworth
Applications:	T300, T450, T600A, T800, W900 1995 - 2002
Position:	Front Left
Notes:	wo/Vent Window
OE Number:	K294426PAK

Interior Door Handle 761-5407



Make:	Kenworth
Applications:	T300, T450, T600A, T800, W900 1995 - 2002
Position:	Front Right
Notes:	wo/Vent Window
OE Number:	K294426RPA

Manifold Absolute Pressure Sensor 904-7033



Make:	Kenworth
Applications:	Caterpillar C12 engines 2000 - 2000
Position:	Manifold
Notes:	
OE Number:	1946724, 1619929

Manifold Absolute Pressure Sensor 904-7037



Make:	Kenworth
Applications:	Caterpillar C11 engines 2003 - 2006
Position:	Manifold
Notes:	
OE Number:	2393478

Manifold Absolute Pressure Sensor 904-7107



Make:	Kenworth
Applications:	Cummins ISX 15 engines 2002 - 2006
Position:	Manifold
Notes:	
OE Number:	4928593

Manifold Absolute Pressure Sensor 904-7124



Make:	Kenworth
Applications:	T2000, T300, T600A, T800, TC2000, W900, with Cummins ISB 1999 - 2002
Position:	Manifold
Notes:	
OE Number:	4921497

Manual Trans Shift Boot 924-5405



Make:	Kenworth
Applications:	T170, T2000, T270, T300, T370, T600A, T660, T800, W900 1999 - 2010
Position:	
Notes:	Square Boot
OE Number:	K04279

Manual Trans Shift Boot 924-5406



Make:	Kenworth
Applications:	C500, K300, T170, T2000, T270, T300, T370, T600A, T660, T800, W900 1999 - 2010
Position:	
Notes:	Round Boot
OE Number:	K042702

Power Window Motor and Regulator Assembly 741-5403



Make:	Kenworth
Applications:	T800, W900 2009 - 2010
Position:	Front Left
Notes:	Power Window Regulator w/Motor; Daylite Door
OE Number:	R211005

Power Window Motor and Regulator Assembly 741-5404



Make:	Kenworth
Applications:	T800, W900 2009 - 2010
Position:	Front Right
Notes:	Power Window Regulator w/Motor; Daylite Door
OE Number:	R211005R

Power Window Motor and Regulator Assembly 741-5405



Make:	Kenworth
Applications:	T2000 2003 - 2010
Position:	Front Left
Notes:	Power Window Regulator w/Motor
OE Number:	R216013

KENWORTH

Power Window Motor and Regulator Assembly – Turbocharger Speed Sensor

Power Window Motor and Regulator Assembly 741-5406



Make: Kenworth
Applications: T2000 2003 - 2010
Position: Front Right
Notes: Power Window Regulator w/Motor
OE Number: R216013R

Sensor - Auto Transmission Speed 904-7026



Make: Kenworth
Applications: Caterpillar C11 engines 2004 - 2006
Position: Input
Notes:
OE Number: 2016616

Side Marker Light Assembly 888-5422



Make: Kenworth
Applications: T680 2013 - 2017
Position: Front Right
Notes: Chrome, LED
OE Number: P541211R

Side Marker Light Assembly 888-5423



Make: Kenworth
Applications: T680 2013 - 2017
Position: Front Left
Notes: Chrome, LED
OE Number: P541211

Truck Cab Side Step 157-5402



Make: Kenworth
Applications: C500, K100, K300, T170, T2000, T270, T300, T370, T400, T440, T450, T600A, T660, T800, W900 1996 - 2012
Position:
Notes: 34 In. x 9.5 In.; Battery Box Step
OE Number: K22912098

Truck Cab Side Step 157-5403



Make: Kenworth
Applications: C500, K270, K370, T170, T2000, T270, T300, T370, T440, T660, T700, T800, W900 1996 - 2012
Position:
Notes: 41.3 In. Long x 4.75 In. Wide, Fuel Tank Step
OE Number: K22911693

Truck Cabinet Latch 760-5409



Make: Kenworth
Applications: T600A, T800, W900 2004 - 2015
Position: Right
Notes: Chrome
OE Number: K294321R

Truck Cabinet Latch 760-5410



Make: Kenworth
Applications: T600, T600A, T660, T800, W900 2004 - 2015
Position: Left
Notes: Chrome
OE Number: K294321

Turbocharger Boost Pressure Valve 599-5001



Make: Kenworth
Applications: Cummins ISM 10.8, ISX 15 2005 - 2007
Position:
Notes: Remanufactured
OE Number: 3770742, 4037440, 4039813, 4046304, 2836554, 4040589, 4036195

Turbocharger Boost Sensor 904-7015



Make: Kenworth
Applications: Caterpillar 3126 engines 1995 - 1996
Position:
Notes: Outlet
OE Number: 1619927, 1414120, 3E6379, 1112351, 1212728

Turbocharger Boost Sensor 904-7028



Make: Kenworth
Applications: Caterpillar 3126 engines 1997 - 1998
Position:
Notes: Inlet
OE Number: 1414119, 1946722, 1619925

Turbocharger Speed Sensor 904-7111



Make: Kenworth
Applications: Cummins ISX 11.9, ISX 15 2010 - 2011
Position:
Notes: 2010 EPA Standard
OE Number: 4032173

Turbocharger Speed Sensor	904-7629
	
Make:	Kenworth
Applications:	Paccar MX13 engines 2014 - 2016
Position:	
Notes:	
OE Number:	1834286PE

Turn Signal / Side Marker Light Assembly	888-5420
	
Make:	Kenworth
Applications:	T170, T270, T370, T660 2007 - 2010
Position:	Front Right
Notes:	Amber w/Marker Light bulb
OE Number:	P541085R

Turn Signal / Side Marker Light Assembly	888-5421
	
Make:	Kenworth
Applications:	T170, T270, T370, T660 2007 - 2010
Position:	Front Left
Notes:	Amber w/Marker Light bulb
OE Number:	P541085

Turn Signal Light Assembly	888-5405
	
Make:	Kenworth
Applications:	T170, T270, T370, T440 2007 - 2013
Position:	
Notes:	Amber, Includes bulbs
OE Number:	K256554

Vehicle Speed Sensor	505-5406
	
Make:	Kenworth
Applications:	C500, K100, K300, T170, T2000, T270, T300, T370, T400, T450, T600A, T660, W900 1995 - 2011
Position:	
Notes:	w/Eaton Transmission; w/Internal Tone Ring; Mounts in Tailshaft Housing
OE Number:	Q216005

Washer Fluid Reservoir	603-5401
	
Make:	Kenworth
Applications:	T300 1999 - 2002
Position:	
Notes:	Includes caps, pump, and level sensors (where applicable)
OE Number:	K11420

Washer Fluid Reservoir	603-5402
	
Make:	Kenworth
Applications:	T680 2006 - 2016
Position:	
Notes:	Includes caps, pump, and level sensors (where applicable), w/ BEHR cooling module
OE Number:	NS355001

Window Channel	750-5401
	
Make:	Kenworth
Applications:	T600A, T800, W900 1992 - 2015
Position:	Front Left; Front Right
Notes:	w/Power Windows; wo/Daylight Door
OE Number:	K075466, K0475066

Window Channel	750-5402
	
Make:	Kenworth
Applications:	T600A, T800, W900 1992 - 2015
Position:	Front Left; Front Right
Notes:	w/Manual Windows; wo/Daylight Door
OE Number:	K0475071, K075471

Window Crank Handle	775-5402
	
Make:	Kenworth
Applications:	T300, T600A 2005 - 2007
Position:	Left; Right
Notes:	Black Handle; w/Black Knob
OE Number:	K294418

Windshield Wiper Arm	602-5403
	
Make:	Kenworth
Applications:	T600, T600A, T660, T800 2006 - 2012
Position:	Left
Notes:	J-Hook Style, with washer hose
OE Number:	R23102912

Windshield Wiper Arm	602-5404
	
Make:	Kenworth
Applications:	T600, T600A, T660, T800 2006 - 2012
Position:	Right
Notes:	J-Hook Style, with washer hose
OE Number:	R23102913

KENWORTH

Windshield Wiper Arm

Windshield Wiper Arm

602-5405



Make:	Kenworth
Applications:	T600, T600A, T800, W900 1985 - 2015
Position:	Front Left
Notes:	Single Wiper Style, Includes Blade
OE Number:	R23102922

NEED HELP FINDING AN ABS SENSOR?

DORMAN HD SOLUTIONS HAS YOU COVERED.

SEARCH PRODUCTS

Year/Make/Model

Keyword, Phrase or Part Number

Interchange # or VMRS Code

Looking for an ABS Sensor?

- Select the **SENSOR STYLE** you are looking for.
- Choose the **SENSOR LENGTH (in.)**.
- Pick the **CONNECTOR TYPE** for your ABS Sensor

Additional Resources

[ABS Sensor Poster](#)

[How to Measure Sensor Length](#)

Select Sensor Style

All



Straight Sensor
Select Sensor Lengths
2.27 in



Straight with Flange Sensor
Select Sensor Lengths
0.71 in



Right Angle Sensor
Select Sensor Lengths
1.57 in



Right Angle-Jacketed Sensor
Select Sensor Lengths
1.62 in

Select Sensor Length (in.)

All

0.71

1.57

1.62

2.27

Select Connector Type

All



ABS Sensors

ABS SENSOR SELECTION TOOL

Find the right ABS sensor in 3 easy clicks!
Visit www.DormanHDSolutions.com/abssensors

Accelerator Pedal 699-5501



Make:	Mack
Applications:	MRU 2010 - 2016
Position:	
Notes:	
OE Number:	82734051, 21915482

Accessory Drive Belt Tensioner Tool 924-5528



Make:	Mack
Applications:	CHU, CTP, CXP, CXU, GU7, GU8, MRU, MP8 engines 2006 - 2016
Position:	
Notes:	Aides in replacement of tensioner and tensioner belts
OE Number:	

Cab Door Vent 242-5503



Make:	Mack
Applications:	MR, MRU 1981 - 2014
Position:	Left
Notes:	Black, Paintable
OE Number:	25161633

Diesel Emissions Fluid Filler Cap 904-5501



Make:	Mack
Applications:	CHU, CXU, GU7, GU8, LEU, MRU, Pinnacle, TD700 2009 - 2013
Position:	
Notes:	Non-Locking
OE Number:	21148728

Diesel Particulate Filter Clamp 674-9000



Make:	Mack
Applications:	Cummins ISX Engines 2007 - 2015 2007 - 2015
Position:	
Notes:	w/2007 & 2010 EPA Standards
OE Number:	21445455

EGR Cooler 904-5035



Make:	Mack
Applications:	Cummins ISX 15 2003 - 2007
Position:	
Notes:	Includes all gaskets and hardware
OE Number:	2881783, 3682986, 4089436, 3683435, 4952490, 4956008NX, 4089166, 4956008, 2881783NX, 3683253, 2878071, 3683069, 2869133, 3682806

EGR Cooler Gasket Kit 904-5007



Make:	Mack
Applications:	Cummins Gen 1 ISX 15.0, ISX 15.0, CL700 SubModel, ISX-400, ISX-450, ISX-475, ISX-500, ISX-565, ISX-600 2003 - 2007
Position:	
Notes:	Includes all gaskets and hardware
OE Number:	4309434NX

EGR Valve 904-5001



Make:	Mack
Applications:	Cummins ISX 2003 - 2007
Position:	
Notes:	Fits Engines Manufactured From 09/31/2002, Generation 1, Includes all gaskets and mounting hardware
OE Number:	4955422RX, 3683305, 3682974, 3682954, 3104874, 3682805, 4955422, 4955422NX, 3684004, 3683446

Engine Coolant Level Sensor 924-5506



Make:	Mack
Applications:	CV, GU7, GU8 2004 - 2008
Position:	
Notes:	
OE Number:	25174715, 64MT466

Engine Coolant Level Sensor 924-5516



Make:	Mack
Applications:	LEU, MRU 2008 - 2015
Position:	
Notes:	
OE Number:	21257608

Engine Coolant Pipe 936-5504



Make:	Mack
Applications:	CXN 1992 - 2008
Position:	
Notes:	w/Automatic Transmission
OE Number:	11MF3713M

Engine Coolant Reservoir 603-5501



Make:	Mack
Applications:	CV, GU7, GU8 2004 - 2008
Position:	
Notes:	Non-Pressurized, Includes caps, pump, and level sensors (where applicable)
OE Number:	25133601

MACK

Engine Coolant Reservoir – Engine Oil Drain Plug Gasket

Engine Coolant Reservoir		603-5502
		
Make:	Mack	
Applications:	CV, GU7, GU8 2004 - 2008	
Position:		
Notes:	Pressurized, Includes caps, pump, and level sensors (where applicable), Uses cap 902-5201	
OE Number:	76MF520M, 25174629	

Engine Coolant Reservoir		603-5505
		
Make:	Mack	
Applications:	CHU, CXN, CXU, Pinnacle 2008 - 2015	
Position:		
Notes:	Includes caps, pump, and level sensors (where applicable)	
OE Number:	21846997, 22061290, 20968795, 21074569, 21000194, 21074555, 22564837, 21314361, 21067134, 21513975, 21038101	

Engine Coolant Reservoir Cap		902-5502
		
Make:	Mack	
Applications:	CHU, CV, CXN, CXU, GU7, GU8, LEU, MRU, Pinnacle, Vision 2004 - 2008	
Position:		
Notes:	10 PSI	
OE Number:	5481991623	

Engine Crankshaft Position Sensor		904-7705
		
Make:	Mack	
Applications:	Mack MP7 engines 2008 - 2015	
Position:		
Notes:		
OE Number:	21426987	

Engine Oil Dipstick		917-5505
		
Make:	Mack	
Applications:	LEU with MP7 engine 2008 - 2010	
Position:		
Notes:	Dipstick w/Tube	
OE Number:	21500925, MK21500925	

Engine Oil Dipstick		917-5507
		
Make:	Mack	
Applications:	CH, CL, DM, DMM, LE, MR, RB, RD, Vision, E7 engines 1990 - 2000	
Position:		
Notes:	Dipstick Only	
OE Number:	795GB373P7	

Engine Oil Dipstick		917-5508
		
Make:	Mack	
Applications:	CH, CL, CV, DM, DMM, LE, MH, MR, R, RB, RD, RM, RW, E7 engines 1989 - 2005	
Position:		
Notes:	Dipstick Only	
OE Number:	795GB377A	

Engine Oil Drain Plug		090-5002
		
Make:	Mack	
Applications:	Cummins ISL, L10 engines 1974 - 2014	
Position:		
Notes:		
OE Number:	3055069	

Engine Oil Drain Plug		090-5003
		
Make:	Mack	
Applications:	Cummins ISX 11.9, ISX 11.9G, ISX 15.0 1998 - 2015	
Position:		
Notes:		
OE Number:	4926565	

Engine Oil Drain Plug		090-5004
		
Make:	Mack	
Applications:	Detroit Diesel Series 60 Engines 1987 - 2015	
Position:		
Notes:		
OE Number:	23505720	

Engine Oil Drain Plug Gasket		095-5002
		
Make:	Mack	
Applications:	Cummins ISL, L10 Engines 1981 - 2010	
Position:		
Notes:		
OE Number:	67946	

Engine Oil Drain Plug Gasket		095-5003
		
Make:	Mack	
Applications:	Cummins ISX 11.9, ISX 15.0 1998 - 2015	
Position:		
Notes:		
OE Number:	3678606	

Engine Oil Pressure Sensor	904-5050
	
Make:	Mack
Applications:	Cummins ISX 11.9, ISX 11.9G, ISX 15.0, ISX 2004 - 2016
Position:	
Notes:	
OE Number:	4921517

Engine Oil Pressure Sensor	904-7109
	
Make:	Mack
Applications:	Cummins ISX engines 2000 - 2003
Position:	
Notes:	
OE Number:	4921475

Engine Oil Pressure Sensor	904-7241
	
Make:	Mack
Applications:	Cummins ISM 10.8 engines 2000 - 2002
Position:	
Notes:	
OE Number:	4921477

Exterior Door Handle	760-5211
	
Make:	Mack
Applications:	CH, CL, Vision 1990 - 2005
Position:	Left
Notes:	Chrome
OE Number:	20QX42M

Exterior Door Handle	760-5212
	
Make:	Mack
Applications:	CH, CL, Vision 1990 - 2005
Position:	Right
Notes:	Chrome
OE Number:	20QX41M

Exterior Door Handle	760-5501
	
Make:	Mack
Applications:	LE 1997 - 2007
Position:	Front Left
Notes:	Black
OE Number:	25192012, 20QX415M

Exterior Door Handle	760-5502
	
Make:	Mack
Applications:	CF, CH, CHN, CL, CL700, CM, CT, CV, CX, CXN 1990 - 2005
Position:	Front Left
Notes:	Black; Accepts 1 Rod; Metal Rod Retainer
OE Number:	25191926, 20QX427M

Exterior Door Handle	760-5512
	
Make:	Mack
Applications:	MR 1987 - 2002
Position:	Front Right
Notes:	Chrome
OE Number:	20QX41M

Exterior Door Handle	760-5516
	
Make:	Mack
Applications:	CF, CH, CHN, CL, CL700, CM, CT, CV, CX, CXN 1990 - 2005
Position:	Front Right
Notes:	Black; Accepts 1 Rod; Metal Rod Retainer
OE Number:	25191953, 20QX426M

Exterior Door Handle	760-5523
	
Make:	Mack
Applications:	CX, CXN, CXP, CXU 2000 - 2015
Position:	Front Right
Notes:	Black; Plastic Rod Retainer
OE Number:	84148227

Exterior Door Handle	761-5507
	
Make:	Mack
Applications:	DM, DMC, DMM, R, RB, RD, RD800, RW, RWL, RWS 1981 - 2007
Position:	Front
Notes:	Chrome
OE Number:	55Q523

Fuel Tank Sending Unit	285-5501
	
Make:	Mack
Applications:	GU7, GU8 2008 - 2011
Position:	
Notes:	Direct fit, Includes gaskets and hardware
OE Number:	20566665, 20506805

MACK

Fuel Tank Sending Unit – Headlight Assembly

Fuel Tank Sending Unit	285-5503
	
Make:	Mack
Applications:	DM, MR 1991 - 2003
Position:	
Notes:	Direct Fit, Models w/Rectangular Tank, Includes gaskets and hardware
OE Number:	16MB48DP13

Fuel Tank Sending Unit	285-5504
	
Make:	Mack
Applications:	CV 2002 - 2008
Position:	
Notes:	Direct fit, Includes gaskets and hardware
OE Number:	25172995, 16MB48DP24, 25172994, 16MB48DP25

Fuel Tank Sending Unit	285-5505
	
Make:	Mack
Applications:	CHU, CXU, Pinnacle 2008 - 2010
Position:	
Notes:	Direct fit, Includes gaskets and hardware
OE Number:	16MB48DP29

Fuel Tank Sending Unit	285-5506
	
Make:	Mack
Applications:	CH, Vision 1995 - 2003
Position:	
Notes:	Direct fit, Includes gaskets and hardware
OE Number:	25101400, 16MB48DP22

Fuel Tank Sending Unit	285-5507
	
Make:	Mack
Applications:	RD 1989 - 2007
Position:	
Notes:	Direct fit, Includes gaskets and hardware
OE Number:	16MB48DP4, 25195325

Fuel Tank Sending Unit	285-5508
	
Make:	Mack
Applications:	CH, CHU, CL, CS200P Mid-Liner, CS250P Mid-Liner, CS300P Mid-Liner, CS300T Mid-Liner, CV, CXN, CXP, CXU, DM, DMM, GU7, GU8, LE, LEU, MR, MRU, MS200P Mid-Liner, MS250P Mid-Liner, MS300P Mid-Liner, MS300T Mid-Liner, Pinnacle, RB, RD, TD700, Vision 1991 - 2011
Position:	
Notes:	Universal Fit, Includes gaskets and hardware
OE Number:	8609NC2759

Grille	242-5502
	
Make:	Mack
Applications:	CHU, CXN, CXP, CXU, Pinnacle, Vision 1999 - 2014
Position:	Front
Notes:	Exc. Rawhide Submodel, Includes bug screen and mounting hardware
OE Number:	6MFS80M, 20791629, 25166278

Headlight Assembly	888-5501
	
Make:	Mack
Applications:	CH, CL 1991 - 2007
Position:	Right
Notes:	Set Back Axle, Includes bulbs
OE Number:	25163253

Headlight Assembly	888-5502
	
Make:	Mack
Applications:	CH, CL 1991 - 2007
Position:	Left
Notes:	Set Back Axle, Includes bulbs
OE Number:	25154252

Headlight Assembly	888-5503
	
Make:	Mack
Applications:	CV, GU7, GU8 2007 - 2009
Position:	Right
Notes:	Includes bulbs
OE Number:	2M0525AM, 25166301, 21836341

Headlight Assembly	888-5504
	
Make:	Mack
Applications:	CV, GU7, GU8 2007 - 2009
Position:	Left
Notes:	Includes bulbs
OE Number:	2M0526AM, 21836340, 25166303

Headlight Assembly	888-5515
	
Make:	Mack
Applications:	CH 1990 - 2006
Position:	Left, Right
Notes:	Set Forward Axle, Lense only
OE Number:	21077000, 2M0516CM

Headlight Bezel **889-5501**



Make:	Mack
Applications:	CH, CL 1995 - 2002
Position:	Left, Right
Notes:	Set Back Front Axle, Chrome
OE Number:	731395475

Headlight Bezel **889-5502**



Make:	Mack
Applications:	CH, CL 1995 - 2002
Position:	Left, Right
Notes:	Standard Front Axle, Black plastic
OE Number:	731367831

Headlight Bezel **889-5503**



Make:	Mack
Applications:	RB, RD 1995 - 2000
Position:	Left, Right
Notes:	Single Square Headlight, Black plastic
OE Number:	215161698, 25161698

Hood Hinge Spring **938-5501**



Make:	Mack
Applications:	CXN, Vision, CX, CXP 1999 - 2007
Position:	
Notes:	Silver
OE Number:	25171284

Hood Hinge Spring **938-5502**



Make:	Mack
Applications:	CH 1999 - 2003
Position:	
Notes:	Silver
OE Number:	25158019

Hood Latch Assembly **315-5502**



Make:	Mack
Applications:	CH, Vision 2001 - 2015
Position:	Right
Notes:	Contains all brackets
OE Number:	0055554, 55554, 25169065, 374129560

Hood Latch Assembly **315-5503**



Make:	Mack
Applications:	CH, Vision 2002 - 2015
Position:	Left
Notes:	Contains all brackets
OE Number:	25159428

Hood Restraint Cable **924-5501**



Make:	Mack
Applications:	CH models with Axle Forward 1990 - 1995
Position:	
Notes:	
OE Number:	25152850

Hood Restraint Cable **924-5502**



Make:	Mack
Applications:	RD 1990 - 2000
Position:	
Notes:	
OE Number:	25171452

Hood Restraint Cable **924-5521**



Make:	Mack
Applications:	CX 1996 - 2007
Position:	
Notes:	32.5 In. Cable Length
OE Number:	25163167

HVAC Heater Blend Door Actuator **604-5104**



Make:	Mack
Applications:	CV, CXN, CXP, Pinnacle, Vision 2000 - 2011
Position:	
Notes:	4 Pin Connector; Label ID No. B3570874A, w/Bergstrom Air Conditioning; 4 Pin Connector; Label ID No. B3570874A
OE Number:	651261, RD5146090P, 2115003, 2383, 100830, 7787650694, 2503207C1, MA1640, MA1705

HVAC Heater Blend Door Actuator **604-5155**



Make:	Mack
Applications:	CH, CHN, CHU, CL, CS200P Mid-Liner, CS250P Mid-Liner, CS300P Mid-Liner, CV, CXN, CXP, CXU, DM, DMM, Freedom, GU7, GU8, LE, LEU, MR, MRU, MS200P Mid-Liner, MS250P Mid-Liner, MS300P Mid-Liner, MV200, MV300, Pinnacle, RB, RD, TD700, Vision 2000 - 2015
Position:	
Notes:	Mode; 4 Pin Connector
OE Number:	H2491, 3543H2491

MACK

Interior Door Handle – Multi Function Switch

Interior Door Handle		761-5503
		
Make:	Mack	
Applications:	LE, LEU 1996 - 2015	
Position:	Right	
Notes:	w/ Solid Door	
OE Number:	25191954	

Interior Door Handle		761-5505
		
Make:	Mack	
Applications:	LE, LEU 1995 - 2015	
Position:	Front Right	
Notes:	Black	
OE Number:	25171286	

Interior Door Handle		761-5506
		
Make:	Mack	
Applications:	LE, LEU 1995 - 2015	
Position:	Front Left	
Notes:	Black	
OE Number:	25171285	

Interior Door Handle		761-5509
		
Make:	Mack	
Applications:	CV 2001 - 2008	
Position:	Front Right	
Notes:	Black	
OE Number:	25165571, 200X313M	

Interior Door Handle		761-5510
		
Make:	Mack	
Applications:	CV 2001 - 2008	
Position:	Front Left	
Notes:	Black	
OE Number:	25165572, 200X314M	

Manifold Absolute Pressure Sensor		904-7107
		
Make:	Mack	
Applications:	Cummins ISX 15 engines 2002 - 2006	
Position:	Manifold	
Notes:		
OE Number:	4928593	

Manifold Absolute Pressure Sensor		904-7142
		
Make:	Mack	
Applications:	Cummins ISX 15 engines 2000 - 2000	
Position:		
Notes:		
OE Number:	4921473	

Multi Function Switch		978-5502
		
Make:	Mack	
Applications:	DM, MR, MRU 1986 - 2015	
Position:		
Notes:	Black	
OE Number:	1MR571	

Multi Function Switch		978-5503
		
Make:	Mack	
Applications:	CH, CV, CXN 1989 - 2008	
Position:		
Notes:	Internal Mount to Column, Black	
OE Number:	1MR575	

Multi Function Switch		978-5504
		
Make:	Mack	
Applications:	CH, CV, CXN 1989 - 2008	
Position:		
Notes:	External Mount to Column, Black	
OE Number:	1MR574	

Multi Function Switch		978-5505
		
Make:	Mack	
Applications:	RD 1987 - 1995	
Position:		
Notes:	5 Wire Harness; Chrome Lever	
OE Number:	1MR3412	

Multi Function Switch		978-5506
		
Make:	Mack	
Applications:	RD 1987 - 1995	
Position:		
Notes:	8 Wire Harness; Chrome Lever	
OE Number:	1MR2201P1, 1MR2201P2	

Power Steering Fluid Dipstick 917-5506



Make: Mack
Applications: RD 1995 - 2003
Position:
Notes: All Models Using a Fleetguard Reservoir
OE Number: MK5839Q347

Suspension Wear Plate 924-5510



Make: Mack
Applications: CH, CHN, CL, CV, CXN, GU7, GU8, Vision, VN, VNL, VNM, VT 2005 - 2012
Position: Rear Left; Rear Right
Notes: w/Hendrickson HAS Air Ride Suspension
OE Number: 20703083

Tachometer Sensor 505-5501



Make: Mack
Applications: CH, RD 1987 - 1995
Position:
Notes: Exc. Magnum 430HP
OE Number: 64MT2105M

Tachometer Sensor 505-5504



Make: Mack
Applications: CH, MR 1990 - 2003
Position:
Notes: Magnum 430HP
OE Number: 64MT435

Tachometer Sensor 505-5506



Make: Mack
Applications: CH, RD 1990 - 2003
Position:
Notes: Exc. Magnum 430HP; wo/Eaton Transmission
OE Number: 64MT440M

Tilt Cab Lock 315-5520



Make: Mack
Applications: LEU, MR, MRU 1991 - 2012
Position: Left, Right
Notes:
OE Number: 184QS39301, 233QS44M, 184QS39301, 25152013, 25158598

Truck Cab Side Step 157-5507



Make: Mack
Applications: CHU, CV, CXN, CXP, CXU, GU7, GU8, LEU, MRU, Pinnacle, TD700, Vision 2005 - 2011
Position:
Notes: 63.5 In. Long x 5 In. Wide
OE Number: 85QM4192M6, MK85QM4192

Truck Cab Side Step 157-5508



Make: Mack
Applications: CHU, CV, CXN, CXP, CXU, GU7, GU8, LEU, MRU, Pinnacle, TD700, Vision 2005 - 2011
Position:
Notes: 62 In. Long x 5 In. Wide
OE Number: 85QM4192M4, 20816521

Truck Cab Side Step 157-5509



Make: Mack
Applications: CH, CHN, CHU, CL, CT, CTP, CV, CX, CXN, CXP, CXU, DM, GU7, GU8, LE, LEU, MR, MRU, RB, RD, TD700, Vision 2005 - 2011
Position:
Notes: 21.5 In. Long x 6 In. Wide
OE Number: 25173208

Truck Cab Side Step 157-5510



Make: Mack
Applications: CHU, CV, CXN, CXP, CXU, GU7, GU8, LEU, MRU, Pinnacle, TD700, Vision 2005 - 2011
Position:
Notes: 36 In. Long x 5 In. Wide x 2 In. High
OE Number: 85QM4224AM, 25168803

Turbocharger Boost Pressure Valve 599-5001



Make: Mack
Applications: Cummins ISM 10.8, ISX 15 2005 - 2007
Position:
Notes: Remanufactured
OE Number: 3770742, 4037440, 4039813, 4046304, 2836554, 4040589, 4036195

Turn Signal Light 888-5516



Make: Mack
Applications: CH 1990 - 2006
Position:
Notes: Set Back Front Axle, Lense only, Amber
OE Number: 731395480

MACK

Vehicle Speed Sensor – Window Crank Handle

Vehicle Speed Sensor	505-5505
	
Make:	Mack
Applications:	CHU, CHN, CL, CV, CXP, DM, CXU, GU7, GU8, LEU, MRU, Pinnacle, TD700, 1989 - 2010
Position:	
Notes:	w/Eaton Transmission; Screw In Style; 1 Connector w/2 Terminals
OE Number:	25166488

Vehicle Speed Sensor	505-5507
	
Make:	Mack
Applications:	CH, DM, MR, RD 1981 - 1990
Position:	
Notes:	2 Connectors w/2 Terminals Each
OE Number:	64MT412M

Vehicle Speed Sensor	505-5512
	
Make:	Mack
Applications:	CHU, CXU, GU7, GU8, LEU, MRU, Pinnacle, TD700, CV, CH, CHN, CV 1991 - 2011
Position:	
Notes:	1 Connector w/3 Terminals, Push In Style; 1 Connector w/3 Terminals
OE Number:	20706327

Washer Fluid Reservoir	603-5503
	
Make:	Mack
Applications:	MR 1991 - 2003
Position:	
Notes:	Includes caps, pump, and level sensors (where applicable)
OE Number:	25128217

Washer Fluid Reservoir	603-5512
	
Make:	Mack
Applications:	RD 1987 - 2002
Position:	
Notes:	w/Reservoir Located In Passenger Door, Includes caps, pump, and level sensors (where applicable)
OE Number:	25128543

Window Channel	750-5501
	
Make:	Mack
Applications:	MR, MRU 1990 - 2011
Position:	Front Left
Notes:	Manual Regulator
OE Number:	25191519

Window Channel	750-5502
	
Make:	Mack
Applications:	MR, MRU 1990 - 2011
Position:	Front Right
Notes:	w/Manual Windows
OE Number:	25191690

Window Channel	750-5503
	
Make:	Mack
Applications:	RD 1990 - 2001
Position:	Front Left
Notes:	w/Manual Windows
OE Number:	25037510

Window Channel	750-5504
	
Make:	Mack
Applications:	CH, CHN, CHU, CXN, CXP, CXU, Pinnacle, Vision 1995 - 2009
Position:	Front Left; Front Right
Notes:	Right and Left applications w/Manual Windows
OE Number:	25161760

Window Channel	750-5505
	
Make:	Mack
Applications:	RD 1990 - 2001
Position:	Front Right
Notes:	w/Manual Windows
OE Number:	25195366

Window Crank Handle	775-5501
	
Make:	Mack
Applications:	CH, CHU, CV, CXP, CXU, GU7, GU8, Pinnacle 1995 - 2009
Position:	Left; Right
Notes:	Black Handle; w/Black Knob
OE Number:	25127753, 2517753, 20QX33AM25, 20QX33AM

Window Crank Handle	775-5502
	
Make:	Mack
Applications:	CH, CHU, CV, CXP, CXU, GU7, GU8, Pinnacle 1995 - 2009
Position:	Left; Right
Notes:	Chrome Handle; w/Black Knob
OE Number:	25127752

Window Regulator 740-5501

Make:	Mack
Applications:	MR 1991 - 2003
Position:	Front Left
Notes:	Manual Window Regulator; Crank Assembly Portion
OE Number:	25191027

Window Regulator 740-5502

Make:	Mack
Applications:	MR 1991 - 2003
Position:	Front Right
Notes:	Manual Window Regulator; Crank Assembly Portion
OE Number:	25191633

Window Regulator 740-5503

Make:	Mack
Applications:	MR 1991 - 2003
Position:	Front Left
Notes:	Manual Window Regulator; Scissor Assembly Portion
OE Number:	25113357

Window Regulator 740-5504

Make:	Mack
Applications:	MR 1991 - 2003
Position:	Front Right
Notes:	Manual Window Regulator; Scissor Assembly Portion
OE Number:	25114490

Window Regulator 740-5505

Make:	Mack
Applications:	RD 1990 - 2000
Position:	Front Left
Notes:	Manual Window Regulator
OE Number:	25161668

Window Regulator 740-5506

Make:	Mack
Applications:	RD 1990 - 2000
Position:	Front Right
Notes:	Manual Window Regulator
OE Number:	25160158

Window Regulator 740-5507

Make:	Mack
Applications:	CH 1997 - 2002
Position:	Front Left
Notes:	Manual Window Regulator
OE Number:	25169077

Window Regulator 740-5508

Make:	Mack
Applications:	CH 1997 - 2002
Position:	Front Right
Notes:	Manual Window Regulator
OE Number:	25169076

HAVE A TECHNICAL QUESTION?

Our certified technicians have the answers. Call us at:

800-868-5777 x5501

DormanHDSolutions.com

PETERBILT

Clutch Starter Safety Switch – EGR Cooler Gasket Kit

Clutch Starter Safety Switch 901-0003

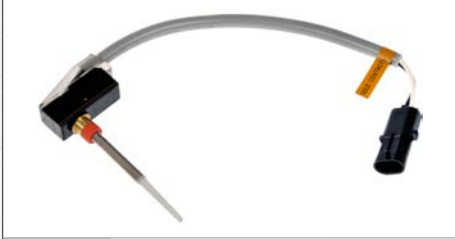

Make:	Peterbilt
Applications:	378, 379 1985 - 2009
Position:	
Notes:	
OE Number:	1604996

Dashboard Air Vent 216-5407



Make:	Peterbilt
Applications:	357, 375, 377, 378 1987 - 2000
Position:	Center
Notes:	Black
OE Number:	1703568

Dashboard Air Vent 216-5408



Make:	Peterbilt
Applications:	357, 375, 377, 378 1987 - 2000
Position:	Left, Right
Notes:	Black
OE Number:	1703806

Dashboard Air Vent 216-5409



Make:	Peterbilt
Applications:	388, 389 2001 - 2005
Position:	Center, Left, Right
Notes:	Black
OE Number:	F451002

Diesel Emissions Fluid Filler Cap 904-5401

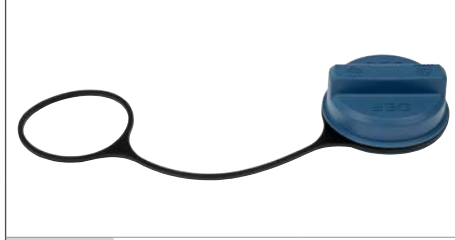

Make:	Peterbilt
Applications:	210, 320, 330, 335, 337, 362, 365, 384, 387, 388 2010 - 2012
Position:	
Notes:	
OE Number:	908022301

Diesel Particulate Filter Clamp 674-9000



Make:	Peterbilt
Applications:	Cummins ISX Engines 2007 - 2015
Position:	
Notes:	w/2007 & 2010 EPA Standards
OE Number:	21445455

Differential Oil Temperature Sensor 505-5401



Make:	Peterbilt
Applications:	379 1987 - 2007
Position:	
Notes:	
OE Number:	Q211002

Door Check Strap 924-5401



Make:	Peterbilt
Applications:	357, 377, 378, 379 1987 - 2005
Position:	
Notes:	Kit includes 3 pieces for full repair
OE Number:	2012066, 2011525M00, 2018727, R656019

EGR Cooler 904-5035



Make:	Peterbilt
Applications:	Cummins ISX 15 2003 - 2007
Position:	
Notes:	Includes all gaskets and hardware
OE Number:	2881783, 3682986, 4089436, 3683435, 4952490, 4956008NX, 4089166, 4956008, 2881783NX, 3683253, 2878071, 3683069, 2869133, 3682806

EGR Cooler 904-5036



Make:	Peterbilt
Applications:	Cummins ISM 2003 - 2007
Position:	
Notes:	Includes all gaskets and hardware
OE Number:	4089380, 3102803, 4089380NX

EGR Cooler Gasket Kit 904-5007





Make:	Peterbilt
Applications:	Cummins Gen 1 ISX 15.0, ISX 15.0, CL700 SubModel, ISX-400, ISX-450, ISX-475, ISX-500, ISX-565, ISX-600 2003 - 2007
Position:	
Notes:	Includes all gaskets and hardware
OE Number:	4309434NX

EGR Cooler Gasket Kit 904-5008



Make:	Peterbilt
Applications:	ISX 15.0, ISX-400, ISX-450, ISX-475, ISX-500, ISX-565, ISX-600 2007 - 2010
Position:	
Notes:	Includes all gaskets and hardware
OE Number:	2881784, 4309398, 4309248, 4309248NX, 4955467, 3684448, 2881747, 2881784NX, 2881747NX, 4955926, 4309398NX

EGR Cooler Gasket Kit	904-5009
	
Make:	Peterbilt
Applications:	Cummins ISX 11.9, ISX 15 2010 - 2011
Position:	
Notes:	Includes all gaskets and hardware
OE Number:	4309491NX

EGR Cooler Gasket Kit	904-5010
	
Make:	Peterbilt
Applications:	Cummins ISM 2002 - 2006
Position:	
Notes:	Generation 1, Includes all gaskets and hardware
OE Number:	4089380NX

EGR Cooler Gasket Kit	904-5011
	
Make:	Peterbilt
Applications:	Cummins ISM 10.8 2007 - 2010
Position:	
Notes:	Generation 2, Includes all gaskets and hardware
OE Number:	2881725NX

EGR Valve	904-5001
	
Make:	Peterbilt
Applications:	Cummins ISX 2003 - 2007
Position:	
Notes:	Fits Engines Manufactured From 09/31/2002, Generation 1, Includes all gaskets and mounting hardware
OE Number:	4955422RX, 3683305, 3682974, 3682954, 3104874, 3682805, 4955422, 4955422NX, 3684004, 3683446

EGR Valve	904-5002
	
Make:	Peterbilt
Applications:	Cummins ISM 2003 - 2007
Position:	
Notes:	Fits Engines Manufactured From 09/31/2002, Generation 1, Includes all gaskets and mounting hardware
OE Number:	4921905, 3104875, 4955421, 3103765, 4955421RX, 3103824, 3103361, 2102745

Engine Camshaft Position Sensor	904-7017
	
Make:	Peterbilt
Applications:	Caterpillar C15 engines 2004 - 2005
Position:	Center Upper
Notes:	
OE Number:	2016617

Engine Camshaft Position Sensor	904-7129
	
Make:	Peterbilt
Applications:	200, 378, Cummins ISB 5.9 1998 - 2001
Position:	
Notes:	
OE Number:	4921597

Engine Coolant Pipe	936-5401
	
Make:	Peterbilt
Applications:	357, 377, Cummins N14 1990 - 1996
Position:	Lower
Notes:	Stainless
OE Number:	0706464

Engine Coolant Pipe	936-5402
	
Make:	Peterbilt
Applications:	357, 379, Caterpillar C15 2003 - 2005
Position:	Lower
Notes:	Stainless
OE Number:	0706462

Engine Coolant Reservoir	603-5403
	
Make:	Peterbilt
Applications:	335, 337, 340, 362, 365, 367, 379, 384, 385, 386, 387, 388 1997 - 2015
Position:	
Notes:	Includes caps, pump, and level sensors (where applicable), w/ BEHR cooling module
OE Number:	N5346001

Engine Coolant Reservoir Cap	902-5402
	
Make:	Peterbilt
Applications:	330, 335, 362, 365, 367, 384, 386, 387, 388, 389 2008 - 2010
Position:	
Notes:	w/Hose Nipple(s), 15 PSI
OE Number:	N5348001

Engine Coolant Reservoir Cap	902-5403
	
Make:	Peterbilt
Applications:	330, 335, 362, 365, 367, 384, 386, 387, 388, 389 2008 - 2010
Position:	
Notes:	wo/Hose Nipple(s)
OE Number:	RC0050

PETERBILT

Engine Coolant Reservoir Cap – Engine Oil Drain Plug Gasket

Engine Coolant Reservoir Cap 902-5404



Make:	Peterbilt
Applications:	357, 362, 375, 377 1990 - 2005
Position:	
Notes:	
OE Number:	63361

Engine Coolant Temperature Sensor 904-7039



Make:	Peterbilt
Applications:	Caterpillar 3406 engines 1994 - 1997
Position:	
Notes:	
OE Number:	1022240

Engine Crankshaft Position Sensor 904-7020



Make:	Peterbilt
Applications:	Caterpillar 3126BTA6 engines 2002 - 2003
Position:	Rear Left Rearward
Notes:	
OE Number:	1693300, 1194142, 2454630

Engine Crankshaft Position Sensor 904-7021



Make:	Peterbilt
Applications:	Caterpillar C11 engines 2004 - 2006
Position:	Rear Left
Notes:	
OE Number:	2016615

Engine Crankshaft Position Sensor 904-7123



Make:	Peterbilt
Applications:	Cummins ISB 5.9 1998 - 2001
Position:	Front
Notes:	
OE Number:	4921601

Engine Oil Drain Plug 090-5001



Make:	Peterbilt
Applications:	Caterpillar 3176, C10, C11, C12, C13, 1989 - 2013
Position:	
Notes:	
OE Number:	9X6451

Engine Oil Drain Plug 090-5002



Make:	Peterbilt
Applications:	Cummins ISL, L10 engines 1974 - 2014
Position:	
Notes:	
OE Number:	3055069

Engine Oil Drain Plug 090-5003



Make:	Peterbilt
Applications:	Cummins ISX 11.9, ISX 11.9G, ISX 15.0 1998 - 2015
Position:	
Notes:	
OE Number:	4926565

Engine Oil Drain Plug 090-5004



Make:	Peterbilt
Applications:	Detroit Diesel Series 60 Engines 1987 - 2015
Position:	
Notes:	
OE Number:	23505720

Engine Oil Drain Plug Gasket 095-5001



Make:	Peterbilt
Applications:	Caterpillar 3176, C10, C11, C12, C13 engines 1989 - 2013
Position:	
Notes:	
OE Number:	619458

Engine Oil Drain Plug Gasket 095-5002



Make:	Peterbilt
Applications:	Cummins ISL, L10 Engines 1981 - 2010
Position:	
Notes:	
OE Number:	67946

Engine Oil Drain Plug Gasket 095-5003



Make:	Peterbilt
Applications:	Cummins ISX 11.9, ISX 15.0 1998 - 2015
Position:	
Notes:	
OE Number:	3678606

Engine Oil Pressure Sensor 904-5050



Make:	Peterbilt
Applications:	Cummins ISX 11.9, ISX 11.9G, ISX 15.0, ISX 2004 - 2016
Position:	
Notes:	
OE Number:	4921517

Engine Oil Pressure Sensor 904-7012



Make:	Peterbilt
Applications:	Caterpillar 3126 engines 1999 - 2000
Position:	
Notes:	
OE Number:	2244536, 1946726

Engine Oil Pressure Sensor 904-7016



Make:	Peterbilt
Applications:	Caterpillar C10 engines 1998 - 1999
Position:	
Notes:	
OE Number:	1619930, 3E7570, 1112350

Engine Oil Pressure Sensor 904-7027



Make:	Peterbilt
Applications:	Caterpillar C15 engines 2004 - 2005
Position:	
Notes:	
OE Number:	1946725

Engine Oil Pressure Sensor 904-7109



Make:	Peterbilt
Applications:	Cummins ISX engines 2000 - 2003
Position:	
Notes:	
OE Number:	4921475

Engine Oil Pressure Sensor 904-7241



Make:	Peterbilt
Applications:	Cummins ISM 10.8 engines 2000 - 2002
Position:	
Notes:	
OE Number:	4921477

Exhaust Manifold 674-5002



Make:	Peterbilt
Applications:	Caterpillar C16 engines 2001 - 2004
Position:	
Notes:	Includes gaskets and hardware
OE Number:	1501914, CT1333359

Exterior Door Handle 760-5401



Make:	Peterbilt
Applications:	330, 357, 362, 375, 377, 378, 379 1983 - 2005
Position:	Front Left
Notes:	Chrome Handle; w/Vent Window
OE Number:	2008179L

Exterior Door Handle 760-5402



Make:	Peterbilt
Applications:	330, 357, 362, 375, 377, 378, 379 1983 - 2005
Position:	Front Right
Notes:	Chrome Handle; w/Vent Window
OE Number:	2008179R

Exterior Door Handle 760-5403



Make:	Peterbilt
Applications:	325, 330, 357, 386, 389 2006 - 2016
Position:	Front Left
Notes:	Black; Chrome Handle; wo/Vent Window
OE Number:	R561025

Exterior Door Handle 760-5408



Make:	Peterbilt
Applications:	325, 330, 357, 386, 389 2006 - 2016
Position:	Front Right
Notes:	Black; Chrome Handle; wo/Vent Window
OE Number:	R561025R

Exterior Door Handle 760-5421



Make:	Peterbilt
Applications:	330, 349, 353, 357, 359, 362, 377, 378, 379 1975 - 2005
Position:	Right
Notes:	Black
OE Number:	2013412R

PETERBILT

Exterior Door Handle – Headlight Assembly

Exterior Door Handle	760-5422
	
Make:	Peterbilt
Applications:	330, 349, 353, 357, 359, 362, 377, 378, 379 1975 - 2005
Position:	Left
Notes:	Black
OE Number:	2013412L

Exterior Door Handle	760-5425
	
Make:	Peterbilt
Applications:	200, 200-33, 330, 357, 362, 375, 377, 378, 379 1987 - 2005
Position:	Right
Notes:	Chrome; w/Sleeper Cab
OE Number:	2903610R

Exterior Door Handle	760-5426
	
Make:	Peterbilt
Applications:	200, 200-33, 330, 357, 362, 375, 377, 378, 379 1987 - 2005
Position:	Left
Notes:	Chrome; w/Sleeper Cab
OE Number:	2903610L

Fog Light	888-5414
	
Make:	Peterbilt
Applications:	579, 587 2008 - 2015
Position:	Front, Left or Right
Notes:	Includes Bulb
OE Number:	PS41062100

Fuel Pressure Sensor	904-7018
	
Make:	Peterbilt
Applications:	Caterpillar C15 engines 2006 - 2008
Position:	
Notes:	
OE Number:	2842728, 2482168

Fuel Pressure Sensor	904-7029
	
Make:	Peterbilt
Applications:	Caterpillar C7 engines 2005 - 2007
Position:	
Notes:	
OE Number:	2482169

Fuel Tank Sending Unit	285-5401
	
Make:	Peterbilt
Applications:	200, 200-33, 210, 220, 224, 227, 265, 270, 320, 325, 330, 335, 337, 340, 348, 349, 353, 357, 359, 362, 365, 367, 372, 375, 376, 377, 378, 379, 382, 384, 385, 386, 387, 388, 389, 567, 587 1987 - 2011
Position:	
Notes:	Direct Fit; 26 In. Diameter Fuel Tank, Includes gasket and hardware
OE Number:	K216004661, 5549137152, K216001660, K216001661

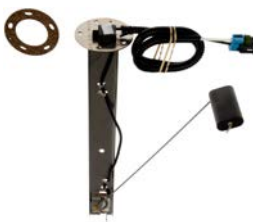
Fuel Tank Sending Unit	285-5402
	
Make:	Peterbilt
Applications:	200, 200-33, 210, 220, 224, 227, 265, 270, 320, 325, 330, 335, 337, 340, 348, 349, 353, 357, 359, 362, 365, 367, 372, 375, 376, 377, 378, 379, 382, 384, 385, 386, 387, 388, 389, 567, 587 1987 - 2011
Position:	
Notes:	Direct Fit; 23 In. Diameter Fuel Tank, Includes gasket and hardware
OE Number:	K216001585

Fuel Tank Sending Unit	285-5403
	
Make:	Peterbilt
Applications:	200, 200-33, 210, 220, 224, 227, 265, 270, 320, 325, 330, 335, 337, 340, 348, 349, 353, 357, 359, 362, 365, 367, 372, 375, 376, 377, 378, 379, 382, 384, 385, 386, 387, 388, 389, 567, 587 1987 - 2011
Position:	
Notes:	Universal Fit, Includes gasket and hardware
OE Number:	391PLP, SW391PLP

Fuel Tank Strap	578-5406
	
Make:	Peterbilt
Applications:	200, 200-33, 210, 220, 224, 227, 265, 270, 320, 325, 330, 335, 337, 340, 348, 349, 353, 357, 359, 362, 365, 367, 372, 375, 376, 377, 378, 379, 382, 384, 385, 386, 387, 388, 389, 567, 587 1987 - 2011
Position:	
Notes:	26 In. Diameter Tank w/T Bolt Mounting
OE Number:	1104551001

Fuel Tank Strap	578-5407
	
Make:	Peterbilt
Applications:	200, 200-33, 224, 227, 265, 270, 320, 330, 335, 349, 353, 357, 359, 362, 372, 375, 376, 377, 378, 379, 382, 384, 385, 387, 388, 389, 567, 587 1987 - 2005
Position:	
Notes:	26 In. Diameter Fuel Tank w/T Bolt mounting wo/Webbing
OE Number:	1103596

Headlight Assembly	888-5403
	
Make:	Peterbilt
Applications:	386, 387 2006 - 2015
Position:	Right
Notes:	Includes bulbs
OE Number:	1609190R

Headlight Assembly 888-5404



Make:	Peterbilt
Applications:	386, 387 2006 - 2015
Position:	Left
Notes:	Includes bulbs
OE Number:	1609190L

Headlight Bezel 889-5409



Make:	Peterbilt
Applications:	377 1987 - 1996
Position:	Right
Notes:	Chrome
OE Number:	1607043R

Headlight Bezel 889-5410



Make:	Peterbilt
Applications:	377 1987 - 1996
Position:	Left
Notes:	Chrome
OE Number:	1607043L

Hood Hinge Spring 938-5406



Make:	Peterbilt
Applications:	357, 377, 379 1987 - 2006
Position:	
Notes:	127 In. Hood; Blue
OE Number:	1304638

Hood Hinge Spring 938-5407



Make:	Peterbilt
Applications:	357, 377, 378, 379 1987 - 2006
Position:	
Notes:	119 In. Hood; Black
OE Number:	1303569

Hood Restraint Cable 924-5402



Make:	Peterbilt
Applications:	357, 375, 377, 378, 379 1987 - 2005
Position:	
Notes:	Length 28.5", Stainless Steel
OE Number:	L926000071

HVAC Heater Blend Door Actuator 604-5113



Make:	Peterbilt
Applications:	330, 335, 340, 357, 378, 379, 385, 386, 388, 389 1994 - 2011
Position:	
Notes:	4 Pin Connector; Red; Label ID No. 52402589
OE Number:	2417002, P93CAB0201, MB0201015, 5X012834, 5X012578, S21278, 5X010029, 651272, ZGG717065, 101431, 2379

HVAC Heater Control Knob 702-5401



Make:	Peterbilt
Applications:	330, 335, 357, 367, 375, 378, 379, 384, 386, 387 1987 - 2011
Position:	
Notes:	Sprague HVAC System
OE Number:	1210001000

HVAC Heater Control Valve Actuator 604-5402



Make:	Peterbilt
Applications:	320 1997 - 2011
Position:	
Notes:	4-Pin Connector
OE Number:	MA16000

HVAC Heater Water Shut-Off Valve Actuator 604-5103



Make:	Peterbilt
Applications:	210, 220, 325, 330, 337, 348, 365, 367, 382, 384, 385, 386, 388, 389, 579, 587 1988 - 2015
Position:	
Notes:	4 Pin Connector, 4 Pin Connector; For Sleeper Cab Unit, 4 Pin Connector; Label No A35130293A
OE Number:	104305, 101632, 641030, 651273, 651259, 317700, 3947430, 2199011, ABPN833011, DA1040, 2199066, 2199069, 71R3575, 3020965, MA1685, RD563200, 5X012834, 3685800C1, MA0200015, 00031247, RD563200P, 00090191, 00063495, 71R3571, 3947439, 101032, H9635, ZGG71705

Interior Door Handle 760-5419



Make:	Peterbilt
Applications:	330, 349, 353, 357, 359, 362, 377, 378, 379 1975 - 2005
Position:	Right
Notes:	Chrome
OE Number:	2008180R

Manifold Absolute Pressure Sensor 904-7033



Make:	Peterbilt
Applications:	Caterpillar C12 engines 2000 - 2000
Position:	Manifold
Notes:	
OE Number:	1946724, 1619929

PETERBILT

Manifold Absolute Pressure Sensor – Sensor - Auto Transmission Speed

Manifold Absolute Pressure Sensor 904-7037



Make: Peterbilt
Applications: Caterpillar C11 engines 2003 - 2006
Position: Manifold
Notes:
OE Number: 2393478

Manifold Absolute Pressure Sensor 904-7107



Make: Peterbilt
Applications: Cummins ISX 15 engines 2002 - 2006
Position: Manifold
Notes:
OE Number: 4928593

Manifold Absolute Pressure Sensor 904-7124



Make: Peterbilt
Applications: Cummins ISB 1999 - 2002
Position: Manifold
Notes:
OE Number: 4921497

Multi Function Switch 978-5409



Make: Peterbilt
Applications: 320 1993 - 2007
Position:
Notes: Black, Chrome
OE Number: 1604415

Multi Function Switch 978-5411



Make: Peterbilt
Applications: 377, 378, 379 1987 - 1998
Position:
Notes: Black, Chrome; 8 Wire Harness w/relay; 16 bulb capacity
OE Number: 1606432, TL10750

Multi Function Switch 978-5412



Make: Peterbilt
Applications: 377, 378, 379 1987 - 1998
Position:
Notes: Black, Chrome; 17 Wire Harness w/relay; 16 bulb capacity
OE Number: TL10900, 1603827

Power Window Motor and Regulator Assembly 741-5401

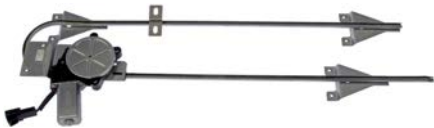

Make: Peterbilt
Applications: 357, 378, 379 1987 - 2005
Position: Front Left
Notes: Power Window Regulator w/Motor
OE Number: R216011

Power Window Motor and Regulator Assembly 741-5402

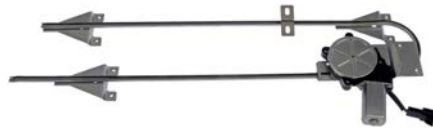

Make: Peterbilt
Applications: 357, 378, 379 1987 - 2005
Position: Front Right
Notes: Power Window Regulator w/Motor
OE Number: R216011R

Power Window Motor and Regulator Assembly 741-5405



Make: Peterbilt
Applications: 386, 387 2003 - 2010
Position: Front Left
Notes: Power Window Regulator w/Motor
OE Number: R216013

Power Window Motor and Regulator Assembly 741-5406



Make: Peterbilt
Applications: 386, 387 2003 - 2010
Position: Front Right
Notes: Power Window Regulator w/Motor
OE Number: R216013R

Roof Marker Light 888-5406



Make: Peterbilt
Applications: 377, 379, 382, 384, 385, 386, 387, 567, 587 1997 - 2014
Position:
Notes: Amber Lense, Incandescent Bulb
OE Number: 1609924001

Sensor - Auto Transmission Speed 904-7026



Make: Peterbilt
Applications: Caterpillar C11 engines 2004 - 2006
Position: Input
Notes:
OE Number: 2016616

Side Marker Light Assembly 888-5411



Make:	Peterbilt
Applications:	386 2006 - 2014
Position:	Front
Notes:	Amber lense, LED Bulb
OE Number:	P546008111

Truck Cab Side Step 157-5403



Make:	Peterbilt
Applications:	210, 220, 320, 325, 330, 337, 348, 362, 377, 379, 382, 384, 385, 387, 388, 389, 567 1996 - 2012
Position:	
Notes:	41.3 In. Long x 4.75 In. Wide, Fuel Tank Step
OE Number:	K22911693

Turbocharger Boost Pressure Valve 599-5001



Make:	Peterbilt
Applications:	Cummins ISM 10.8, ISX 15 2005 - 2007
Position:	
Notes:	Remanufactured
OE Number:	3770742, 4037440, 4039813, 4046304, 2836554, 4040589, 4036195

Turbocharger Boost Sensor 904-7015



Make:	Peterbilt
Applications:	Caterpillar 3126 engines 1995 - 1996
Position:	
Notes:	Outlet
OE Number:	1619927, 1414120, 3E6379, 1112351, 1212728

Turbocharger Boost Sensor 904-7028



Make:	Peterbilt
Applications:	Caterpillar 3126 engines 1997 - 1998
Position:	
Notes:	Inlet
OE Number:	1414119, 1946722, 1619925

Turbocharger Speed Sensor 904-7111



Make:	Peterbilt
Applications:	Cummins ISX 11.9, ISX 15 2010 - 2011
Position:	
Notes:	2010 EPA Standard
OE Number:	4032173

Turbocharger Speed Sensor 904-7629



Make:	Peterbilt
Applications:	Paccar MX13 engines 2014 - 2016
Position:	
Notes:	
OE Number:	1834286PE

Vehicle Speed Sensor 505-5406



Make:	Peterbilt
Applications:	200, 200-33, 210, 220, 270, 320, 330, 335, 337, 340, 357, 362, 365, 367, 375, 377, 379, 384, 385, 386, 387, 388, 389, ATX 1995 - 2011
Position:	
Notes:	w/Eaton Transmission; w/Internal Tone Ring; Mounts in Tailshaft Housing
OE Number:	Q216005

Vehicle Speed Sensor 505-5407



Make:	Peterbilt
Applications:	200, 200-33, 210, 220, 270, 320, 330, 335, 337, 340, 357, 362, 365, 367, 375, 377, 379, 384, 385, 386, 387, 388, 389, ATX 1995 - 2011
Position:	
Notes:	w/Eaton Transmission; w/External Tone Ring, w/Eaton Transmission; w/External Tone Ring; w/2 Pin Connector
OE Number:	3095533, K3454

Vehicle Speed Sensor 505-5408



Make:	Peterbilt
Applications:	200, 200-33, 210, 220, 270, 320, 330, 335, 337, 340, 357, 362, 365, 367, 375, 377, 379, 384, 385, 386, 387, 388, 389, ATX 1995 - 2011
Position:	
Notes:	w/Eaton Transmission; w/External Tone Ring; w/4 Pin Connector
OE Number:	K3455

Washer Fluid Reservoir 603-5402



Make:	Peterbilt
Applications:	320, 330, 335, 340, 357, 362, 365, 367, 378, 379, 382, 384, 385, 386, 387, 388, 389, with Caterpillar or Cummins engine 2006 - 2016
Position:	
Notes:	Includes caps, pump, and level sensors (where applicable), w/ BEHR cooling module
OE Number:	N535001

Washer Fluid Reservoir 603-5404



Make:	Peterbilt
Applications:	357, 375, 377, 379 1990 - 2005
Position:	
Notes:	Includes caps, pump, and level sensors (where applicable)
OE Number:	R866001

PETERBILT

Washer Fluid Reservoir Cap – Windshield Washer Nozzle

Washer Fluid Reservoir Cap	902-5401
	
Make:	Peterbilt
Applications:	335, 362, 365, 367, 384, 386, 387, 388, 389 2008 - 2010
Position:	
Notes:	Fits OEM Reservoir No. N5355001 and Dorman Reservoir No. 603-5402
OE Number:	C57205

Window Crank Handle	775-5604
	
Make:	Peterbilt
Applications:	320, 330, 335, 337, 340, 357, 362, 365, 367, 375, 377, 379, 385, 387, 388, 389 1990 - 2011
Position:	
Notes:	Chrome Handle; w/Chrome Knob
OE Number:	1205091

Windshield Washer Nozzle	924-5403
	
Make:	Peterbilt
Applications:	330, 335, 357, 367, 375, 377, 378, 379, 388, 389 1987 - 2011
Position:	Front
Notes:	Kit Includes Three Nozzles
OE Number:	106811

Windshield Wiper Arm	602-5411
	
Make:	Peterbilt
Applications:	379 1990 - 2007
Position:	
Notes:	Includes washer hose and nozzle
OE Number:	R236002

HD CAB REPAIR

A Broad Range of Commonly Replaced Interior Cab Components

REPAIR COMPONENTS INCLUDE:

- Air Door Actuators
- Door Hinge Assemblies
- Hood Control Cables
- Hood Latch Assemblies
- HVAC Knob Kits
- Multi-Function Switches
- Window Channels
- Wiper Nozzle Kits
- **AND MORE!**



315-5401
Kenworth 2015-87



604-5103
Fits over
30 Different models!



978-5201
Freightliner M2, Thomas C2 2015-03

EGR Cooler **904-5036**



Make:	Sterling
Applications:	Cummins ISM 2003 - 2007
Position:	
Notes:	Includes all gaskets and hardware
OE Number:	4089380, 3102803, 4089380NX

EGR Pressure Feedback Sensor **904-5052**



Make:	Sterling
Applications:	Cummins ISB 2006 - 2014
Position:	Exhaust Gas Temperature
Notes:	2007 and 2010 EPA Emission Standard
OE Number:	4928594, 4921746

EGR Valve **904-5002**



Make:	Sterling
Applications:	Cummins ISM 2003 - 2007
Position:	
Notes:	Fits Engines Manufactured From 09/31/2002, Generation 1, Includes all gaskets and mounting hardware
OE Number:	4921905, 3104875, 4955421, 3103765, 4955421RX, 3103824, 3103361, 2102745

EGR Valve **904-5073**



Make:	Sterling
Applications:	Mercedes-Benz MBE4000 engines 2003 - 2006
Position:	
Notes:	2003 EPA Standard, Includes all gaskets and mounting hardware
OE Number:	RA46014204

Engine Camshaft Position Sensor **904-7017**



Make:	Sterling
Applications:	Caterpillar C15 engines 2004 - 2005
Position:	Center Upper
Notes:	
OE Number:	2016617

Engine Camshaft Position Sensor **904-7129**



Make:	Sterling
Applications:	Cummins ISB 1998-2001
Position:	
Notes:	
OE Number:	4921597

Engine Coolant Temperature Sensor **904-7039**



Make:	Sterling
Applications:	Caterpillar 3406 engines 1994 - 1997
Position:	
Notes:	
OE Number:	1022240

Engine Crankshaft Position Sensor **904-7020**



Make:	Sterling
Applications:	Caterpillar 3126BTA6 engines 2002 - 2003
Position:	Rear Left Rearward
Notes:	
OE Number:	1693300, 1194142, 2454630

Engine Crankshaft Position Sensor **904-7021**



Make:	Sterling
Applications:	Caterpillar C11 engines 2004 - 2006
Position:	Rear Left
Notes:	
OE Number:	2016615

Engine Crankshaft Position Sensor **904-7024**



Make:	Sterling
Applications:	Caterpillar C15 engines 2003 - 2004
Position:	Rear
Notes:	
OE Number:	1918303

Engine Crankshaft Position Sensor **904-7123**



Make:	Sterling
Applications:	Cummins ISB 5.9 1998 - 2001
Position:	Front
Notes:	
OE Number:	4921601

Engine Oil Drain Plug **090-5002**



Make:	Sterling
Applications:	Cummins ISL, L10 engines 1974 - 2014
Position:	
Notes:	
OE Number:	3055069

STERLING

Engine Oil Drain Plug – Fuel Pressure Sensor

Engine Oil Drain Plug 090-5004



Make:	Sterling
Applications:	Detroit Diesel Series 60 Engines 1987 - 2015
Position:	
Notes:	
OE Number:	23505720

Engine Oil Drain Plug Gasket 095-5002



Make:	Sterling
Applications:	Cummins ISL, L10 Engines 1981 - 2010
Position:	
Notes:	
OE Number:	67946

Engine Oil Pressure Sensor 904-7012



Make:	Sterling
Applications:	Caterpillar 3126 engines 1999 - 2000
Position:	
Notes:	
OE Number:	2244536, 1946726

Engine Oil Pressure Sensor 904-7016



Make:	Sterling
Applications:	Caterpillar C10 engines 1998 - 1999
Position:	
Notes:	
OE Number:	1619930, 3E7570, 1112350

Engine Oil Pressure Sensor 904-7027



Make:	Sterling
Applications:	Caterpillar C15 engines 2004 - 2005
Position:	
Notes:	
OE Number:	1946725

Engine Oil Pressure Sensor 904-7109



Make:	Sterling
Applications:	Cummins ISX engines 2000 - 2003
Position:	
Notes:	
OE Number:	4921475

Exhaust Manifold 674-5002



Make:	Sterling
Applications:	Caterpillar C16 engines 2001 - 2004
Position:	
Notes:	Includes all gaskets and hardware
OE Number:	1501914, CT1333359

Exterior Door Handle 760-5213



Make:	Sterling
Applications:	360, 825, 827, A9500, A9513, AT9500, AT9513, AT9522, Bullet 45, Bullet 55, Conдор, Fire Truck, L7501, L8500, L8501, L9500, L77500, L77501, L78500, L78501, L78511, L79500, L79501, M5500, M6500, M7500, M8500, SC7000 Cargo, SC8000 Cargo, ST9500 1987 - 2010
Position:	Front Left
Notes:	Black
OE Number:	HLK2171, F4HZ802240

Exterior Door Handle 760-5214



Make:	Sterling
Applications:	360, 825, 827, A9500, A9513, AT9500, AT9513, AT9522, Bullet 45, Bullet 55, Conдор, Fire Truck, L7501, L8500, L8501, L9500, L77500, L77501, L78500, L78501, L78511, L79500, L79501, M5500, M6500, M7500, M8500, SC7000 Cargo, SC8000 Cargo, ST9500 1987 - 2010
Position:	Front Right
Notes:	Black
OE Number:	F4HZ802240, HLK2172

Exterior Door Handle 760-5215



Make:	Sterling
Applications:	Acterra, Acterra 5500, Acterra 6500, Acterra 7500, Acterra 8500 2000 - 2009
Position:	Front Left
Notes:	Black
OE Number:	A185191300, A185191300

Exterior Door Handle 760-5216



Make:	Sterling
Applications:	Acterra, Acterra 5500, Acterra 6500, Acterra 7500, Acterra 8500 2000 - 2009
Position:	Front Right
Notes:	Black
OE Number:	A185191300, A185191300

Fuel Pressure Sensor 904-7018





Make:	Sterling
Applications:	Caterpillar C15 engines 2006 - 2008
Position:	
Notes:	
OE Number:	2842728, 2482168

Fuel Pressure Sensor	904-7029
	
Make:	Sterling
Applications:	Caterpillar C7 engines 2005 - 2007
Position:	
Notes:	
OE Number:	2482169

Headlight Assembly	888-5301
	
Make:	Sterling
Applications:	A9500, A9513, A9522, AT9500, AT9513, AT9522 1997 - 2009
Position:	Right
Notes:	Bulbs included
OE Number:	A171334400

Headlight Assembly	888-5302
	
Make:	Sterling
Applications:	A9500, A9513, A9522, AT9500, AT9513, AT9522 1997 - 2009
Position:	Left
Notes:	Bulbs included
OE Number:	A171334400

Manifold Absolute Pressure Sensor	904-7033
	
Make:	Sterling
Applications:	Caterpillar C12 engines 2000 - 2000
Position:	Manifold
Notes:	
OE Number:	1946724, 1619929

Manifold Absolute Pressure Sensor	904-7037
	
Make:	Sterling
Applications:	Caterpillar C11 engines 2003 - 2006
Position:	Manifold
Notes:	
OE Number:	2393478

Manifold Absolute Pressure Sensor	904-7124
	
Make:	Sterling
Applications:	200, Acterra 5500, Acterra 6500, Acterra 7500 1999 - 2002
Position:	Manifold
Notes:	
OE Number:	4921497

Manifold Absolute Pressure Sensor	904-7142
	
Make:	Sterling
Applications:	Cummins ISX 15 engines 2000 - 2000
Position:	
Notes:	
OE Number:	4921473

Sensor - Auto Transmission Speed	904-7026
	
Make:	Sterling
Applications:	Caterpillar C11 engines 2004 - 2006
Position:	Input
Notes:	
OE Number:	2016616

Side Marker Light Assembly	888-5303
	
Make:	Sterling
Applications:	A9500, A9513, A9522, AT9500, AT9513, AT9522, L8000, L8501, L8511, L8513, L9000, L9501, L9511, L9513, L9522, LA8000, LT8500, LT8501, LT8511, LT8513, LT9500, LT9501, LT9511, LT9513, LT9522 1998 - 2009
Position:	Front Right
Notes:	Amber
OE Number:	F6HZ15A201

Side Marker Light Assembly	888-5304
	
Make:	Sterling
Applications:	A9500, A9513, A9522, AT9500, AT9513, AT9522, L8000, L8501, L8511, L8513, L9000, L9500, L9501, L9511, L9513, L9522, LA8000, LT8500, LT8501, LT8511, LT8513, LT9500, LT9501, LT9511, LT9513, LT9522 1998 - 2009
Position:	Front Left
Notes:	Amber
OE Number:	F6HZ15A201

Throttle Body Motor	341-5001
	
Make:	Sterling
Applications:	Detroit Diesel DD13, DD15, DD16, DD60 series engines 1987 - 2015
Position:	
Notes:	Remanufactured
OE Number:	RA46009000, A460098031, A460098021

Turbocharger Boost Sensor	904-7015
	
Make:	Sterling
Applications:	Caterpillar 3126 engines 1995 - 1996
Position:	
Notes:	Outlet
OE Number:	1619927, 1414120, 3E6379, 1112351, 1212728

STERLING

Turbocharger Boost Sensor – Window Crank Handle

Turbocharger Boost Sensor **904-7028**



Make:	Sterling
Applications:	Caterpillar 3126 engines 1997 - 1998
Position:	
Notes:	Inlet
OE Number:	1414119, 1946722, 1619925

Turbocharger Boost Sensor **904-7254**



Make:	Sterling
Applications:	Detroit Diesel Series 60 engines 2007 - 2007
Position:	
Notes:	
OE Number:	23527829

Window Crank Handle **775-5203**



Make:	Sterling
Applications:	Acterra, Acterra 5500, Acterra 6500, Acterra 7500, Acterra 8500 2000 - 2009
Position:	Left; Right
Notes:	Black
OE Number:	A185982800

LIGHTING SOLUTIONS

Complete lighting coverage visit www.DormanHDSolutions.com



Avoid CSA points by easily replacing cracked or hazed lighting assemblies.

DORMAN HD SOLUTIONS LIGHTING PRODUCTS FEATURE THE FOLLOWING BENEFITS:

- ALL DORMAN HD HEADLIGHTS ARE COATED WITH A TWO-COMPONENT, THERMALLY CURED SILICONE HARD COATING, WHICH IS RECOMMENDED BY TMC*

– COATING HELPS PREVENT HEADLIGHT'S SURFACE FROM HAZING



*TECHNOLOGY & MAINTENANCE COUNCIL

Accessory Drive Belt Tensioner Tool 924-5528



Make:	Volvo
Applications:	VAH, VHD, VN, VNL, VNM, D13 engines 2006 - 2016
Position:	
Notes:	Aides in replacement of tensioner and tensioner belts
OE Number:	

Battery Cable 242-5529



Make:	Volvo
Applications:	VN, VNL, VNM 2004 - 2015
Position:	Negative; Positive
Notes:	4 Hole
OE Number:	21107829, 21107828

Battery Cable 242-5530



Make:	Volvo
Applications:	VN, VNL, VNM 2004 - 2015
Position:	Negative; Positive
Notes:	3 Hole
OE Number:	21107822, 21107826

Diesel Emissions Fluid Filler Cap 904-5502



Make:	Volvo
Applications:	VAH, VHD, VN, VNL, VNM, VT 2010 - 2016
Position:	
Notes:	Locking
OE Number:	21148725

Diesel Particulate Filter Clamp 674-9000



Make:	Volvo
Applications:	Cummins ISX Engines 2007 - 2015
Position:	
Notes:	w/2007 & 2010 EPA Standards
OE Number:	21445455

Door Latch Cable 924-5514



Make:	Volvo
Applications:	VNL 2005 - 2010
Position:	
Notes:	
OE Number:	20922589, 20922536, 20922537, 8191136

Door Seal 750-5506



Make:	Volvo
Applications:	VN, VNL, VNM 1996 - 2015
Position:	Left
Notes:	Outer Door Seal
OE Number:	21773433

Door Seal 750-5507



Make:	Volvo
Applications:	VN, VNL, VNM 1998 - 2015
Position:	Right, Left
Notes:	Secondary Seal
OE Number:	3175029

Door Seal 750-5508



Make:	Volvo
Applications:	VN, VNL 1996 - 2015
Position:	Front, Top
Notes:	Upper rain seal
OE Number:	3176221

Door Seal 750-5509



Make:	Volvo
Applications:	VN, VNL, VNM 1998 - 2015
Position:	Right
Notes:	Primary Seal
OE Number:	22106235

EGR Cooler 904-5021



Make:	Volvo
Applications:	D12 engines 2003 - 2007
Position:	
Notes:	Includes gaskets, and connector tubes
OE Number:	20562070, 85104380, 85110346, 20567966, 20527754, 20722340, 20739151

EGR Cooler 904-5035





Make:	Volvo
Applications:	Cummins ISX 15 2003 - 2007
Position:	
Notes:	Includes all gaskets and hardware
OE Number:	2881783, 3682986, 4089436, 3683435, 4952490, 4956008NX, 4089166, 4956008, 2881783NX, 3683253, 2878071, 3683069, 2869133, 3682806

VOLVO

EGR Cooler – Engine Coolant Reservoir Cap

EGR Cooler		904-5036
		
Make:	Volvo	
Applications:	ISM 10.8, ISM 10.8, ISM 10.8, ISM 10.8 2003 - 2007	
Position:		
Notes:	Includes all gaskets and hardware	
OE Number:	4089380, 3102803, 4089380NX	

EGR Cooler Gasket Kit		904-5007
		
Make:	Volvo	
Applications:	Cummins Gen 1 ISX 15.0, ISX 15.0, CL700 SubModel, ISX-400, ISX-450, ISX-475, ISX-500, ISX-565, ISX-600 2003 - 2007	
Position:		
Notes:	Includes all gaskets and hardware	
OE Number:	4309434NX	

EGR Cooler Gasket Kit		904-5009
		
Make:	Volvo	
Applications:	Cummins ISX 11.9, ISX 15 2010 - 2011	
Position:		
Notes:	Includes all gaskets and hardware	
OE Number:	4309491NX	

EGR Valve		904-5001
		
Make:	Volvo	
Applications:	Cummins ISX 2003 - 2007	
Position:		
Notes:	Fits Engines Manufactured From 09/31/2002, Generation 1, Includes all gaskets and mounting hardware	
OE Number:	4955422RX, 3683305, 3682974, 3682954, 3104874, 3682805, 4955422, 4955422NX, 3684004, 3683446	

EGR Valve		904-5002
		
Make:	Volvo	
Applications:	Cummins ISM 2003 - 2007	
Position:		
Notes:	Fits Engines Manufactured From 09/31/2002, Generation 1, Includes all gaskets and mounting hardware	
OE Number:	4921905, 3104875, 4955421, 3103765, 4955421RX, 3103824, 3103361, 2102745	

EGR Valve		904-5004
		
Make:	Volvo	
Applications:	VHD, VNL, VNM with D12 engines 2003 - 2007	
Position:		
Notes:	Includes gaskets, and connector tubes	
OE Number:	21001173RM, 21001173, VPT2100117, 20704284, 20506894, 20865398, 20764334, 85000816, 85000908, 85000785	

Engine Coolant Pipe		936-5501
		
Make:	Volvo	
Applications:	VNL, VNM 2001 - 2008	
Position:	Lower	
Notes:	Bypass Tube Assembly, Stainless Steel	
OE Number:	20561364, 20462647, 20469768	

Engine Coolant Pipe		936-5502
		
Make:	Volvo	
Applications:	VHD, VNL, VNM 2000 - 2011	
Position:	Lower	
Notes:	Heater Tube Assembly; To Sleeper Cab Heater, Black Powder Coating	
OE Number:	20357260	

Engine Coolant Reservoir		603-5504
		
Make:	Volvo	
Applications:	VN, VNL, VNM 1997 - 2007	
Position:		
Notes:	Includes caps, pump, and level sensors (where applicable)	
OE Number:	20519039, 20519037	

Engine Coolant Reservoir		603-5505
		
Make:	Volvo	
Applications:	VHD, VN, VNL, VNM 2008 - 2015	
Position:		
Notes:	Includes caps, pump, and level sensors (where applicable)	
OE Number:	21846997, 22061290, 20968795, 21074569, 21000194, 21074555, 22564837, 21314361, 21067134, 21513975, 21038101	

Engine Coolant Reservoir		603-5510
		
Make:	Volvo	
Applications:	WG, WG42, WG42T, WG64, WG64T, WI, WIA42T, WIA64T 1988 - 2000	
Position:		
Notes:	Includes caps, pump, and level sensors (where applicable)	
OE Number:	3966106, 212073202, 212013201, 212013202, 212073201, 3966107	

Engine Coolant Reservoir Cap		902-0064
		
Make:	Volvo	
Applications:	VN, VNL, VNM 1997 - 2007	
Position:		
Notes:	Fill Cap	
OE Number:	20968839	

Engine Coolant Reservoir Cap		902-0065
		
Make:	Volvo	
Applications:	VN, VNL, VNM 1997 - 2007	
Position:		
Notes:	18 psi	
OE Number:	21314359	

Engine Oil Dipstick		917-5501
		
Make:	Volvo	
Applications:	VNL, VT, with Cummins ISX15 2006 - 2015	
Position:		
Notes:	Dipstick Only	
OE Number:	20576425	

Engine Oil Dipstick		917-5502
		
Make:	Volvo	
Applications:	VNL, VT, with Cummins ISX15 2006 - 2015	
Position:		
Notes:	Dipstick w/Tube	
OE Number:	21500943	

Engine Oil Dipstick		917-5503
		
Make:	Volvo	
Applications:	ACL, VHD, WC, WG, WI, with Volvo D12 1996 - 2009	
Position:		
Notes:	Dipstick w/Tube	
OE Number:	21500944	

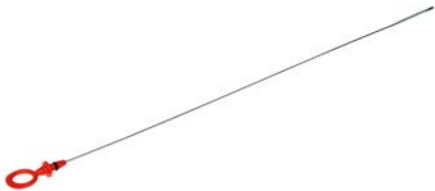
Engine Oil Dipstick		917-5509
		
Make:	Volvo	
Applications:	VN, VNL, VNM, with Volvo D12 2003 - 2012	
Position:		
Notes:	Dipstick Only	
OE Number:	85134599	

Engine Oil Drain Plug		090-5002
		
Make:	Volvo	
Applications:	Cummins ISL, L10 engines 1974 - 2014	
Position:		
Notes:		
OE Number:	3055069	

Engine Oil Drain Plug		090-5003
		
Make:	Volvo	
Applications:	Cummins ISX 11.9, ISX 11.9G, ISX 15.0 1998 - 2015	
Position:		
Notes:		
OE Number:	4926565	

Engine Oil Drain Plug		090-5004
		
Make:	Volvo	
Applications:	Detroit Diesel Series 60 Engines 1987 - 2015	
Position:		
Notes:		
OE Number:	23505720	

Engine Oil Drain Plug Gasket		095-5002
		
Make:	Volvo	
Applications:	Cummins ISL, L10 Engines 1981 - 2010	
Position:		
Notes:		
OE Number:	67946	

Engine Oil Drain Plug Gasket		095-5003
		
Make:	Volvo	
Applications:	Cummins ISX 11.9, ISX 15.0 1998 - 2015	
Position:		
Notes:		
OE Number:	3678606	

Engine Oil Filler Cap		902-5504
		
Make:	Volvo	
Applications:	9700, VHD, VN, VNL, VNM 2007 - 2015	
Position:		
Notes:		
OE Number:	20807510	

Engine Oil Pressure Sensor		904-5050
		
Make:	Volvo	
Applications:	Cummins ISX 11.9, ISX 11.9G, ISX 15.0, ISX 2004 - 2016	
Position:		
Notes:		
OE Number:	4921517	

VOLVO

Engine Oil Pressure Sensor – Headlight Assembly

Engine Oil Pressure Sensor	904-7691
	
Make:	Volvo
Applications:	Volvo D12 engines 2003 - 2008
Position:	
Notes:	
OE Number:	1077574

Exterior Door Handle	760-5509
	
Make:	Volvo
Applications:	WAH, WAH42, WC, WCA62T, WG, WG42, WG42T, WG64, WG64T, WH, WHL64, WI, WIA42T, WIA64T, WX, WX42T, WXL42, WXL64, WXR42, WXR64 1988 - 2004
Position:	Front Left
Notes:	Chrome
OE Number:	84169528, 502720001, 3080801, 502728001, 8165244

Exterior Door Handle	760-5510
	
Make:	Volvo
Applications:	WAH, WAH42, WC, WCA62T, WG, WG42, WG42T, WG64, WG64T, WH, WHL64, WI, WIA42T, WIA64T, WX, WX42T, WXL42, WXL64, WXR42, WXR64 1988 - 2004
Position:	Front Right
Notes:	Chrome
OE Number:	502738001, 502730001, 8165245, 3080802

Fog Light Assembly	888-5509
	
Make:	Volvo
Applications:	VN, VNL 2004 - 2015
Position:	Right
Notes:	Single Bulb Light, Includes bulbs
OE Number:	20546125, 82780933, 20737501, 20434324

Fog Light Assembly	888-5510
	
Make:	Volvo
Applications:	VN, VNL 2004 - 2015
Position:	Left
Notes:	Single Bulb Light, Includes bulbs
OE Number:	20546123, 20434323, 82780931, 20737500

Fog Light Assembly	888-5511
	
Make:	Volvo
Applications:	VNL 2006 - 2009
Position:	Right
Notes:	Double Bulb Light, Includes bulbs
OE Number:	20737497

Fog Light Assembly	888-5512
	
Make:	Volvo
Applications:	VNL 2006 - 2009
Position:	Left
Notes:	Double Bulb Light, Includes bulbs
OE Number:	20737496

Fuel Tank Sending Unit	285-5509
	
Make:	Volvo
Applications:	WAH, WAH42, WG, WX 1990 - 2004
Position:	
Notes:	Direct fit
OE Number:	20378296, 3918002, 85134274, 3939067, 5549507182, 3092995, 8173760, 3946260, 3092993

Grille	242-5513
	
Make:	Volvo
Applications:	VN, VNL, VNM 1998 - 2003
Position:	Front
Notes:	Chrome, Includes bug screen and mounting hardware, Generation 1
OE Number:	8083095, 8084221, 518658, 8072818

Headlight Assembly	888-5505
	
Make:	Volvo
Applications:	VNL 2005 - 2014
Position:	Right
Notes:	Includes bulbs
OE Number:	20835985, 20496654, 20359834, 20817108, 82329127

Headlight Assembly	888-5506
	
Make:	Volvo
Applications:	VNL 2005 - 2014
Position:	Left
Notes:	Includes bulbs
OE Number:	20817107, 82329124, 20359833, 20496653, 20835984

Headlight Assembly	888-5507
	
Make:	Volvo
Applications:	VN, VNL, VNM 2001 - 2014
Position:	Right
Notes:	Includes bulbs
OE Number:	0093660, 1623715, 8082041, 8080015

Headlight Assembly	888-5508
	
Make:	Volvo
Applications:	VN, VNL, VNM 2001 - 2014
Position:	Left
Notes:	Includes bulbs
OE Number:	1623714, 0093659, 8080014, 8082040

Hood Latch Assembly	315-5501
	
Make:	Volvo
Applications:	WC, WCA62T, WG, WI 1991 - 1997
Position:	Left; Right
Notes:	Contains all brackets
OE Number:	8174018

Hood Latch Kit	315-5507
	
Make:	Volvo
Applications:	VN, VNL, VT 2005 - 2012
Position:	
Notes:	Repair kit
OE Number:	8089034, 82210369, 20878651, 20498998, 8081394, 8074949, 8081393, 8089035, 8081359, 20878648

Hood Restraint Cable	924-5503
	
Make:	Volvo
Applications:	VN, VNL 2005 - 2009
Position:	
Notes:	Generation 2
OE Number:	82601061

HVAC Heater Blend Door Actuator	604-5131
	
Make:	Volvo
Applications:	VN, VNL, VNM 1996 - 1998
Position:	
Notes:	3 Pin Connector; Label ID No. T52402591
OE Number:	2199011, 2393, RD587910, RD587910P, ABPN833014, RDHRD58791, 71R3573, 1696831C1, 104306

HVAC Heater Water Shut-Off Valve Actuator	604-5103
	
Make:	Volvo
Applications:	VN, VNL, VNM 1988 - 2015
Position:	
Notes:	4 Pin Connector, 4 Pin Connector; For Sleeper Cab Unit, 4 Pin Connector; Label No A35130293A
OE Number:	104305, 101632, 641030, 651273, 651259, 317700, 3947430, 2199011, ABPN833011, DA1040, 2199066, 2199069, 71R3575, 3020965, MA1685, RD563200, 5X012834, 3685800C1, MA0200015, 00031247, RD563200P, 00090191, 00063495, 71R3571, 3947439, 101032, H9635, ZGG71705

Interior Door Handle	760-5503
	
Make:	Volvo
Applications:	WX42T, WXL42, WXL64, WXR42, WXR64, WAH, WAH42, WC, WCA62T, WG, WG42, WG42T, WG64, WG64T, WH, WHL64, WI, WIA42T, WIA64T, WX 1988 - 2004
Position:	Front Right
Notes:	Chrome
OE Number:	3080800

Interior Door Handle	760-5504
	
Make:	Volvo
Applications:	WAH, WAH42, WC, WCA62T, WG, WG42, WG42T, WG64, WG64T, WH, WHL64, WI, WIA42T, WIA64T, WX, WX42T, WXL42, WXL64, WXR42, WXR64 1988 - 2004
Position:	Front Left
Notes:	Chrome
OE Number:	502708001, 502700002, KS1063134, 3080799, 502700001

Manifold Absolute Pressure Sensor	904-7107
	
Make:	Volvo
Applications:	Cummins ISX 15 engines 2002 - 2006
Position:	Manifold
Notes:	
OE Number:	4928593

Multi Function Switch	978-5501
	
Make:	Volvo
Applications:	VN, VNL 2005 - 2012
Position:	
Notes:	Black
OE Number:	3944025, 20701049, 20399170, 20479584, 20797838

Multi Function Switch	978-5511
	
Make:	Volvo
Applications:	VAH, VHD, VN, VNL, VNM 2004 - 2015
Position:	
Notes:	Black; Generation 2
OE Number:	3172173, 1624137

Multi Function Switch	978-5512
	
Make:	Volvo
Applications:	ACL, WG, WG42, WG42T, WG64, WG64T, WIA42T, WIA64T 1991 - 2000
Position:	
Notes:	Chrome arm
OE Number:	3081533

VOLVO

Power Steering Fluid Dipstick – Truck Cab Side Step

Power Steering Fluid Dipstick	917-5504
	
Make:	Volvo
Applications:	9700, VAH, VHD, VN, VNL, VNM, VT 2005 - 2012
Position:	
Notes:	
OE Number:	3092770

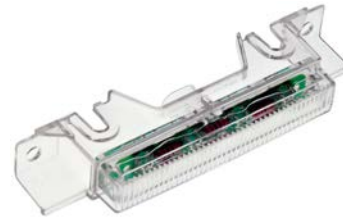
Roof Marker Light	888-5527
	
Make:	Volvo
Applications:	VN, VNL, VNM 2008 - 2017
Position:	
Notes:	Sunvisor Mounted; Clear Lens w/ Amber Diode
OE Number:	21882502, 21016198, 21096165, 82713504

Seat Adjustment Knob	702-5501
	
Make:	Volvo
Applications:	VN, VNL 2005 - 2012
Position:	
Notes:	Gray
OE Number:	85105778

Sun Visor Lamp	924-5519
	
Make:	Volvo
Applications:	VN, VNL, VNM 1996 - 2015
Position:	
Notes:	Amber lense, LED bulbs
OE Number:	85107907, 8073442

Suspension Wear Plate	924-5510
	
Make:	Volvo
Applications:	VN, VNL, VNM, VT 2005 - 2012
Position:	Rear Left; Rear Right
Notes:	w/Hendrickson HAS Air Ride Suspension
OE Number:	20703083

Tachometer Sensor	505-5511
	
Make:	Volvo
Applications:	WC, WG, WH, WI, WX 1990 - 1997
Position:	
Notes:	
OE Number:	8078108

Truck Cab Mount	924-5505
	
Make:	Volvo
Applications:	VHD, VN, VNL 2002 - 2007
Position:	
Notes:	Cab Mount
OE Number:	8074666

Truck Cab Side Step	157-5501
	
Make:	Volvo
Applications:	VAH, VHD, VN, VNL, VNM, VT 2005 - 2015
Position:	
Notes:	13.5 In. Long x 5 In. Wide
OE Number:	8080791, 20489697, 8085900, 20434354

Truck Cab Side Step	157-5502
	
Make:	Volvo
Applications:	VAH, VHD, VN, VNL, VNM, VT 2005 - 2015
Position:	
Notes:	28.5 In. Long x 5 In. Wide
OE Number:	20489701

Truck Cab Side Step	157-5503
	
Make:	Volvo
Applications:	VAH, VHD, VN, VNL, VNM, VT 2005 - 2015
Position:	
Notes:	30 In. Long x 5 In. Wide
OE Number:	20434390, 8164747, 20489702, 8085904

Truck Cab Side Step	157-5504
	
Make:	Volvo
Applications:	VAH, VHD, VN, VNL, VNM, VT 2005 - 2015
Position:	
Notes:	33 In. Long x 5 In. Wide
OE Number:	20434391, 20489703, 8168540, 8085905, 20434361, 8169775

Truck Cab Side Step	157-5505
	
Make:	Volvo
Applications:	VAH, VHD, VN, VNL, VNM, VT 2005 - 2015
Position:	
Notes:	36 In. Long x 5 In. Wide
OE Number:	20489704, 8087410, 20434392

Truck Cab Side Step		157-5506
		
Make:	Volvo	
Applications:	VAH, VHD, VN, VNL, VNM, VT 2005 - 2015	
Position:		
Notes:	42 In. Long x 5 In. Wide	
OE Number:	8168544, 20434394, 20489709, 8085907, 8169778	

Truck Fairing Latch		761-5513
		
Make:	Volvo	
Applications:	VN, VNL 1996 - 2015	
Position:	Rear Right	
Notes:	Black	
OE Number:	20745997	

Truck Fairing Latch		761-5514
		
Make:	Volvo	
Applications:	VN, VNL 1996 - 2015	
Position:	Rear Left	
Notes:	Black	
OE Number:	20745996	

Turbocharger Actuator		599-5002
		
Make:	Volvo	
Applications:	9700, VAH, VHD, VN, VNL, VNM, VT with Volvo D11, D12, D13, D16 2003 - 2015	
Position:		
Notes:	Remanufactured	
OE Number:	21754439	

Turbocharger Boost Pressure Valve		599-5001
		
Make:	Volvo	
Applications:	Cummins ISM 10.8, ISX 15 2005 - 2007	
Position:		
Notes:	Remanufactured	
OE Number:	3770742, 4037440, 4039813, 4046304, 2836554, 4040589, 4036195	

Turbocharger Speed Sensor		904-7111
		
Make:	Volvo	
Applications:	Cummins ISX 11.9, ISX 15 2010 - 2011	
Position:		
Notes:	2010 EPA Standard	
OE Number:	4032173	

Turbocharger Speed Sensor		904-7441
		
Make:	Volvo	
Applications:	D13 engines 2010 - 2016	
Position:		
Notes:		
OE Number:	21508269	

Turn Signal / Parking / Side Marker Light Lens		888-5517
		
Make:	Volvo	
Applications:	VN, VNL, VNM 1998 - 2015	
Position:	Front Right	
Notes:	Amber	
OE Number:	8080853	

Turn Signal / Parking / Side Marker Light Lens		888-5518
		
Make:	Volvo	
Applications:	VN, VNL, VNM 1998 - 2015	
Position:	Front Left	
Notes:	Amber	
OE Number:	8080852	

Vehicle Speed Sensor		505-5510
		
Make:	Volvo	
Applications:	VN, VNL, VNM, WAH, WC, WG, WH, WI 1996 - 2003	
Position:		
Notes:		
OE Number:	8029939	

Washer Fluid Reservoir		603-5506
		
Make:	Volvo	
Applications:	VN, VNL 1997 - 2015	
Position:		
Notes:	Includes caps, pump, and level sensors (where applicable)	
OE Number:	21067134, 21038101, 21314361, 21000194, 82711780, 82714827, 21846997, 22061290, 82711782, 21074569, 20968795, 21074555	

Washer Fluid Reservoir		603-5508
		
Make:	Volvo	
Applications:	VHD 2004 - 2012	
Position:		
Notes:	Includes caps, pump, and level sensors (where applicable)	
OE Number:	22143196, 20481269, 20935852, 20815266, 82712975, 20912202, 20543377, 82716512	

VOLVO

Washer Fluid Reservoir Filler Pipe – Engine Oil Pressure Sensor

Washer Fluid Reservoir Filler Pipe 902-5507



Make:	Volvo
Applications:	VNL 2005 - 2012
Position:	
Notes:	Includes cap
OE Number:	20912204

Window Crank Handle 775-5503



Make:	Volvo
Applications:	VHD, VNL 1998 - 2004
Position:	Front Left; Front Right
Notes:	Light Gray
OE Number:	8140016

Window Crank Handle 775-5504



Make:	Volvo
Applications:	VHD, VNL 2005 - 2013
Position:	Front Left; Front Right
Notes:	Light Gray
OE Number:	20509270

Window Crank Handle 775-5505



Make:	Volvo
Applications:	VHD, VN, VNL, VNM, VT 1996 - 2004
Position:	
Notes:	w/Manual Windows; Dark Gray
OE Number:	20509270

Window Crank Handle 775-5506



Make:	Volvo
Applications:	FE 1992 - 1998
Position:	Front
Notes:	w/Manual Windows; Dark Gray
OE Number:	3953182

Window Regulator 740-5509



Make:	Volvo
Applications:	VN, VNL 1996 - 2015
Position:	Left
Notes:	Mechanical
OE Number:	3176545, 3981924, 1063835, 3176537

Window Regulator 740-5510



Make:	Volvo
Applications:	VN, VNL 1996 - 2015
Position:	Right
Notes:	Mechanical
OE Number:	1063836, 3176538, 3176546

Windshield Washer Nozzle 924-5504



Make:	Volvo
Applications:	VNL 2005 - 2012
Position:	Front
Notes:	Nozzle only
OE Number:	1070123

Engine Oil Pressure Sensor 904-7241



Make:	Volvo
Applications:	Cummins ISM 10.8 engines 2000 - 2002
Position:	
Notes:	
OE Number:	4921477

Engine Oil Pressure Sensor 904-7109



Make:	Volvo
Applications:	Cummins ISX engines 2000 - 2003
Position:	
Notes:	
OE Number:	4921475

Manifold Absolute Pressure Sensor 904-7142



Make:	Volvo
Applications:	Cummins ISX 15 engines 2000 - 2000
Position:	
Notes:	
OE Number:	4921473

Console Multi Function Switch 978-5514



Make:	Western Star
Applications:	4800, 4900, 4900E, 4900EX, 4900FA, 4900SA 1986 - 2002
Position:	
Notes:	Chrome; Self-Canceling
OE Number:	3081534, 844013421

Dashboard Air Vent 216-5901



Make:	Western Star
Applications:	4900, 4900E, 4900EX, 4900FA, 4900SA 2001 - 2010
Position:	Center, Left, Right
Notes:	Black
OE Number:	600563409

Diesel Particulate Filter Clamp 674-9000



Make:	Western Star
Applications:	Cummins ISX Engines 2007 - 2015
Position:	
Notes:	w/2007 & 2010 EPA Standards
OE Number:	21445455

EGR Cooler 904-5035



Make:	Western Star
Applications:	Cummins ISX 15 2003 - 2007
Position:	
Notes:	Includes all gaskets and hardware
OE Number:	2881783, 3682986, 4089436, 3683435, 4952490, 4956008NX, 4089166, 4956008, 2881783NX, 3683253, 2878071, 3683069, 2869133, 3682806

EGR Cooler 904-5036



Make:	Western Star
Applications:	ISM 10.8, ISM 10.8, ISM 10.8, ISM 10.8 2003 - 2007
Position:	
Notes:	Includes all Gaskets and Hardware
OE Number:	4089380, 3102803, 4089380NX

EGR Cooler Gasket Kit 904-5007



Make:	Western Star
Applications:	Cummins Gen 1 ISX 15.0, ISX 15.0, CL700 SubModel, ISX-400, ISX-450, ISX-475, ISX-500, ISX-565, ISX-600 2003 - 2007
Position:	
Notes:	Includes all gaskets and hardware
OE Number:	4309434NX

EGR Cooler Gasket Kit 904-5009



Make:	Western Star
Applications:	Cummins ISX 11.9, ISX 15 2010 - 2011
Position:	
Notes:	Includes all gaskets and hardware
OE Number:	4309491NX

EGR Valve 904-5001



Make:	Western Star
Applications:	Cummins ISX 2003 - 2007
Position:	
Notes:	Fits Engines Manufactured From 09/31/2002, Generation 1, Includes all gaskets and mounting hardware
OE Number:	4955422RX, 3683305, 3682974, 3682954, 3104874, 3682805, 4955422, 4955422NX, 3684004, 3683446

EGR Valve 904-5002



Make:	Western Star
Applications:	Cummins ISM 2003 - 2007
Position:	
Notes:	Fits Engines Manufactured From 09/31/2002, Generation 1, Includes all gaskets and mounting hardware
OE Number:	4921905, 3104875, 4955421, 3103765, 4955421RX, 3103824, 3103361, 2102745

EGR Valve 904-5073



Make:	Western Star
Applications:	Mercedes-Benz MBE4000 engines 2003 - 2006
Position:	
Notes:	2003 EPA Standard, Includes all gaskets and mounting hardware
OE Number:	RA46014204

Engine Camshaft Position Sensor 904-7017



Make:	Western Star
Applications:	Caterpillar C15 engines 2004 - 2005
Position:	Center Upper
Notes:	
OE Number:	2016617

Engine Coolant Temperature Sensor 904-7039



Make:	Western Star
Applications:	Caterpillar 3406 engines 1994 - 1997
Position:	
Notes:	
OE Number:	1022240

WESTERN STAR

Engine Crankshaft Position Sensor – Engine Oil Pressure Sensor

Engine Crankshaft Position Sensor 904-7020



Make:	Western Star
Applications:	Caterpillar 3126BTA6 engines 2002 - 2003
Position:	Rear Left Rearward
Notes:	
OE Number:	1693300, 1194142, 2454630

Engine Crankshaft Position Sensor 904-7021



Make:	Western Star
Applications:	Caterpillar C11 engines 2004 - 2006
Position:	Rear Left
Notes:	
OE Number:	2016615

Engine Crankshaft Position Sensor 904-7024



Make:	Western Star
Applications:	Caterpillar C15 engines 2003 - 2004
Position:	Rear
Notes:	
OE Number:	1918303

Engine Oil Drain Plug 090-5001



Make:	Western Star
Applications:	Caterpillar 3176, C10, C11, C12, C13, 1989 - 2013
Position:	
Notes:	
OE Number:	9X6451

Engine Oil Drain Plug 090-5002



Make:	Western Star
Applications:	Cummins ISL, L10 engines 1974 - 2014
Position:	
Notes:	
OE Number:	3055069

Engine Oil Drain Plug 090-5003



Make:	Western Star
Applications:	Cummins ISX 11.9, ISX 11.9G, ISX 15.0 1998 - 2015
Position:	
Notes:	
OE Number:	4926565

Engine Oil Drain Plug 090-5004



Make:	Western Star
Applications:	Detroit Diesel Series 60 Engines 1987 - 2015
Position:	
Notes:	
OE Number:	23505720

Engine Oil Drain Plug Gasket 095-5001



Make:	Western Star
Applications:	Caterpillar 3176, C10, C11, C12, C13 engines 1989 - 2013
Position:	
Notes:	
OE Number:	619458

Engine Oil Drain Plug Gasket 095-5002



Make:	Western Star
Applications:	Cummins ISL, L10 Engines 1981 - 2010
Position:	
Notes:	
OE Number:	67946

Engine Oil Drain Plug Gasket 095-5003



Make:	Western Star
Applications:	Cummins ISX 11.9, ISX 15.0 1998 - 2015
Position:	
Notes:	
OE Number:	3678606

Engine Oil Pressure Sensor 904-5050



Make:	Western Star
Applications:	Cummins ISX 11.9, ISX 11.9G, ISX 15.0, ISX 2004 - 2016
Position:	
Notes:	
OE Number:	4921517

Engine Oil Pressure Sensor 904-7012



Make:	Western Star
Applications:	Caterpillar 3126 engines 1999 - 2000
Position:	
Notes:	
OE Number:	2244536, 1946726

Engine Oil Pressure Sensor 904-7016



Make:	Western Star
Applications:	Caterpillar C10 engines 1998 - 1999
Position:	
Notes:	
OE Number:	1619930, 3E7570, 1112350

Engine Oil Pressure Sensor 904-7027



Make:	Western Star
Applications:	Caterpillar C15 engines 2004 - 2005
Position:	
Notes:	
OE Number:	1946725

Engine Oil Pressure Sensor 904-7109



Make:	Western Star
Applications:	Cummins ISX engines 2000 - 2003
Position:	
Notes:	
OE Number:	4921475

Engine Oil Pressure Sensor 904-7241



Make:	Western Star
Applications:	Cummins ISM 10.8 engines 2000 - 2002
Position:	
Notes:	
OE Number:	4921477

Exhaust Manifold 674-5002



Make:	Western Star
Applications:	Caterpillar C16 engines 2001 - 2004
Position:	
Notes:	Includes all gaskets and hardware
OE Number:	1501914, CT1333359

Fuel Pressure Sensor 904-7018



Make:	Western Star
Applications:	Caterpillar C15 engines 2006 - 2008
Position:	
Notes:	
OE Number:	2842728, 2482168

Fuel Pressure Sensor 904-7029



Make:	Western Star
Applications:	Caterpillar C7 engines 2005 - 2007
Position:	
Notes:	
OE Number:	2482169

HVAC Heater Water Shut-Off Valve Actuator 604-5103



Make:	Western Star
Applications:	3700, 3800, 4900 1988 - 2015
Position:	
Notes:	4 Pin Connector; Label ID No. A35130293B
OE Number:	ZGG717058, 2118004, H9635, 101432, 651258, MA1430, 2371, S21331, 2380, MA1360, 2370, 650341BSM, 101032, ZGG717002, 3543H9635, 868505BSM, 1696831C1, ABPN833280, 2499080, 2392, ABPN833241, 2117005, 324165BSM, 71R3571, 3020965, MA020001S, 3947439, 00031247,

Manifold Absolute Pressure Sensor 904-7033



Make:	Western Star
Applications:	Caterpillar C12 engines 2000 - 2000
Position:	Manifold
Notes:	
OE Number:	1946724, 1619929

Manifold Absolute Pressure Sensor 904-7037



Make:	Western Star
Applications:	Caterpillar C11 engines 2003 - 2006
Position:	Manifold
Notes:	
OE Number:	2393478

Manifold Absolute Pressure Sensor 904-7107



Make:	Western Star
Applications:	Cummins ISX 15 engines 2002 - 2006
Position:	Manifold
Notes:	
OE Number:	4928593

Manifold Absolute Pressure Sensor 904-7142



Make:	Western Star
Applications:	Cummins ISX 15 engines 2000 - 2000
Position:	
Notes:	
OE Number:	4921473

WESTERN STAR

Sensor - Auto Transmission Speed – Turbocharger Boost Sensor

Sensor - Auto Transmission Speed 904-7026



Make:	Western Star
Applications:	Caterpillar C11 engines 2004 - 2006
Position:	Input
Notes:	
OE Number:	2016616

Throttle Body Motor 341-5001



Make:	Western Star
Applications:	Detroit Diesel DD13, DD15, DD16, DD60 series engines 1987 - 2015
Position:	
Notes:	Remanufactured
OE Number:	RA46009000, A460098031, A460098021

Turbocharger Boost Pressure Valve 599-5001



Make:	Western Star
Applications:	Cummins ISM 10.8, ISX 15 2005 - 2007
Position:	
Notes:	Remanufactured
OE Number:	3770742, 4037440, 4039813, 4046304, 2836554, 4040589, 4036195

Turbocharger Boost Sensor 904-7015



Make:	Western Star
Applications:	Caterpillar 3126 engines 1995 - 1996
Position:	
Notes:	Outlet
OE Number:	1619927, 1414120, 3E6379, 1112351, 1212728

Turbocharger Boost Sensor 904-7028



Make:	Western Star
Applications:	Caterpillar 3126 engines 1997 - 1998
Position:	
Notes:	Inlet
OE Number:	1414119, 1946722, 1619925

Turbocharger Boost Sensor 904-7254



Make:	Western Star
Applications:	Detroit Diesel Series 60 engines 2007 - 2007
Position:	
Notes:	
OE Number:	23527829

Turbocharger Speed Sensor 904-7111



Make:	Western Star
Applications:	Cummins ISX 11.9, ISX 15 2010 - 2011
Position:	
Notes:	2010 EPA Standard
OE Number:	4032173

BE THE FIRST TO KNOW!
ABOUT FORMERLY "DEALER ONLY" PARTS

NEW FORMERLY "DEALER ONLY" PARTS ARE ADDED MONTHLY!

The Be-The-First-To-Know program keeps you updated with email and text updates.

SIGN UP TODAY!

DormanHDSolutions.com/btftk



Growing the size of the
HEAVY DUTY
A f t e r m a r k e t

MEDIUM DUTY MAKES

GM Isuzu Workhorse	78
Hino	82

GM / ISUZU / WORKHORSE

ABS Wheel Speed Sensor – Battery Cover

ABS Wheel Speed Sensor 970-5007



Make:	Chevrolet, GMC
Applications:	C60 Kodiak, C6000 Topkick, C6500 Kodiak, C6500 Topkick, C70 Kodiak, C7000 Topkick, C7500 Kodiak, C7500 Topkick, 1995-2002
Position:	Front Left; Front Right; Rear Left; Rear Right
Notes:	
OE Number:	801566, 15737201, 89026854

ABS Wheel Speed Sensor 970-5601



Make:	Chevrolet, GMC
Applications:	C5500 Kodiak, C5500 Topkick, C6500 Kodiak, C6500 Topkick, C7500 Kodiak, C7500 Topkick, C8500, C8500 Kodiak, C8500 Topkick, T6500, T7500, T8500 2003 - 2009
Position:	Front, Rear
Notes:	Air Brakes (JE4), Hydraulic Brakes (JE3), Hydraulic Brakes; H08, HD1 or HPK Rear Axle Codes
OE Number:	BW801556, 5012274, 745801556, ZAC801467, 5009122, ZAC801556, 5012503, 5012843, 801092, 5010644, 801467, BAN801556, 801251, 801556, BX801556, 20784542

ABS Wheel Speed Sensor 970-5602



Make:	Chevrolet, GMC
Applications:	B7, C60 Kodiak, C6000 Topkick, C6500 Kodiak, C6500 Topkick, C70 Kodiak, C7000 Topkick, C7500 Kodiak, C7500 Topkick, T6500, T7500 1995 - 2002
Position:	Front Left; Front Right, Rear Left; Rear Right
Notes:	90 Degree Bend Sensor, Exc. School Bus
OE Number:	89026854

ABS Wheel Speed Sensor 970-5603



Make:	Chevrolet, GMC
Applications:	C4500 Kodiak, C4500 Topkick, C5500 Kodiak, C5500 Topkick 2003 - 2009
Position:	Front Left; Front Right
Notes:	6,000 Lb. to 6,250 Lb. Front Axle (FK7, FN9 or FR5); 7,000 Lb. Front Axle (FK6 or FM7); 6,250 Lb. Front Axle (FR5); 7,000 Lb. Front Axle (FM7); 7,000 Lb. Front Axle (FM7)
OE Number:	15033710

ABS Wheel Speed Sensor Bracket 970-5600



Make:	Chevrolet, GMC
Applications:	C4500 Kodiak, C5000 Topkick, C5500 Kodiak, C60 Kodiak, C6000 Topkick, C6500 Kodiak, C6500 Topkick, C70 Kodiak, C7000 Topkick, C7500 Kodiak, C7500 Topkick 1990 - 2002
Position:	
Notes:	ABS Retainer
OE Number:	745801534, 8235589975, 8997598154, 5899760815, TDAR955458, S899759815, 8235R95545, R955459, RWSS899759, 2037413C2, WAB8997605, 4C422C218A, TDAS899760, S899759815, S899760510, BX801534, TDAR955459, TDAS899759, R955458, 801534, 15108406, BW801534, 89976051

Auto Trans Oil Cooler 918-5601



Make:	Chevrolet, GMC
Applications:	C4500 Kodiak, C4500 Topkick, C5500 Kodiak, C5500 Topkick, C6500 Kodiak, C6500 Topkick, C7500 Kodiak, C7500 Topkick, C8500, C8500 Kodiak, C8500 Topkick, Kodiak C8500, Topkick C8500 2003 - 2009
Position:	
Notes:	
OE Number:	15833558, 15103877, 15090389, 19259604

Auto Trans Oil Cooler Line Connector 800-5600



Make:	Chevrolet, GMC
Applications:	C3500HD, C4500 Kodiak, C4500 Topkick, C5500 Kodiak, C5500 Topkick, C6500 Kodiak, C6500 Topkick, C7500 Kodiak, C7500 Topkick 2002 - 2003
Position:	
Notes:	L6 475CID 7.8L, V8 496CID 8.1L, Radiator Side; Transmission Oil Cooler Line 5/8 In. Quick Connector w/ 7/8 In. Thread
OE Number:	15194557

Auto Trans Oil Cooler Line Connector 800-5601



Make:	Chevrolet, GMC
Applications:	C4500 Kodiak, C4500 Topkick, C5500 Kodiak, C5500 Topkick 2003 - 2008
Position:	
Notes:	Black; Transmission Oil Cooler Line To Radiator
OE Number:	15170197, 15797464

Auto Trans Oil Cooler Line Connector 800-5601



Make:	Chevrolet, GMC
Applications:	C4500 Kodiak, C4500 Topkick, C5500 Kodiak, C5500 Topkick 2003 - 2009
Position:	
Notes:	Black; Transmission Oil Cooler Line To Radiator
OE Number:	15797464, 15170197

Auto Trans Oil Cooler Line Connector 800-5603



Make:	Chevrolet, GMC
Applications:	C4500 Kodiak, C4500 Topkick, C5500 Kodiak, C5500 Topkick 2003 - 2009
Position:	
Notes:	Transmission Fluid Cooler Pipe Fitting To Case; Allison Automatic Transmission
OE Number:	15865062

Auto Trans Oil Cooler Line Connector 800-5604



Make:	Chevrolet, GMC
Applications:	C6500 Kodiak, C6500 Topkick, C7500 Kodiak, C7500 Topkick, C8500, C8500 Kodiak, C8500 Topkick 2003 - 2003
Position:	
Notes:	Black; Transmission Oil Cooler Line To Radiator; 3/4 In.-19mm
OE Number:	29541729

Battery Cover 242-5601



Make:	Isuzu
Applications:	NPR, NPR-HD, NQR, NRR 2004 - 2007
Position:	
Notes:	
OE Number:	1536120372

GM / ISUZU / WORKHORSE

Clutch Cable – Engine Cooling Fan Assembly

Clutch Cable **924-5604**



Make:	Chevrolet, GMC
Applications:	C60 Kodiak, C6500, C6500 Kodiak, C6500 Topkick, C70 Kodiak, C7500 Kodiak, C7500 Topkick 1990 - 2002
Position:	
Notes:	w/ Manual Transmission
OE Number:	15959451

Diesel Emissions Fluid Filler Cap **904-5601**



Make:	GMC
Applications:	Savana 4500 2010 - 2012
Position:	
Notes:	
OE Number:	22753134

Diesel Emissions Fluid Filler Cap **904-5602**



Make:	Isuzu
Applications:	FTR, NPR, NPR-HD, NRR 2009 - 2012
Position:	
Notes:	
OE Number:	8981202621

Door Hinge **924-5603**



Make:	Isuzu
Applications:	NPR, NPR-HD 1994 - 2000
Position:	
Notes:	
OE Number:	8978520073

Drive Belt Idler Pulley **419-5000**



Make:	Chevrolet, GMC
Applications:	C3500HD 1990 - 1997
Position:	
Notes:	V8 351CID 5.8L, V8 395CID 6.5L, V8 460CID 7.5L, Grooved Pulley
OE Number:	25530911, 15602650, 25530872, F2S26C348A, 12537144, 25526387, 14078850, E8T28678E, E9AZ8678A, E6D26B217B, E8T28678D

Drive Belt Idler Pulley **419-5002**



Make:	Chevrolet, GMC
Applications:	C3500HD 1996 - 2002
Position:	
Notes:	V8 454CID 7.4L, V8 496CID 8.1L wo/Air Conditioning
OE Number:	12559325, 97221943, XF2Z6B209A, 12580774, YS4Z6A228A, 12580772, 2N1Z8678BD, 12569301, F83Z6C348A, F8CZ6C348A, 5R3Z6B209B

Drive Belt Idler Pulley **419-5005**



Make:	Chevrolet, GMC
Applications:	Express 4500, Savana 4500 2010 - 2013
Position:	Left, Smooth Pulley
Notes:	V8 403CID 6.6L (6599cc) Pulley O.D. 76.2 mm, Smooth Pulley; Pulley O.D. 76.2 mm; w/Dual Alternators
OE Number:	98072072

Engine Coolant Reservoir **603-5601**



Make:	Chevrolet, GMC
Applications:	C4500 Kodiak, C6500 Topkick, C7500 Kodiak, C8500 Kodiak, C8500 Topkick 2003 - 2008
Position:	
Notes:	L6 441CID 7.2L, L6 442CID 7.2L, L6 475CID 7.8L, V8 403CID 6.6L (6599cc), V8 496CID 8.1L Includes caps, pump, and level sensors (where applicable)
OE Number:	15161670

Engine Coolant Reservoir **603-5603**



Make:	Isuzu
Applications:	NPR, NPR-HD, NQR, NRR 1996 - 2010
Position:	
Notes:	Includes caps, pump, and level sensors (where applicable)
OE Number:	8975530122

Engine Coolant Reservoir **603-5604**



Make:	Chevrolet, GMC
Applications:	C5000 Topkick, C5500 Kodiak, C60 Kodiak, C6000 Topkick, C6500 Kodiak, C6500 Topkick, C70 Kodiak, C7000 Topkick, C7500 Kodiak, C7500 Topkick 1990 - 1998
Position:	
Notes:	V8 366CID 6.0L, V8 427CID 7.0L (6998cc) Includes caps, pump, and level sensors (where applicable)
OE Number:	15688604

Engine Coolant Reservoir Cap **902-5601**



Make:	Chevrolet, GMC
Applications:	C4500 Kodiak, C4500 Topkick, C5500 Kodiak, C5500 Topkick, C6500 Kodiak, C6500 Topkick, C7500 Kodiak, C7500 Topkick 2003 - 2008
Position:	
Notes:	wo/Coolant Type Requirement, 15 PSI
OE Number:	22652695, 22671020, 15066786

Engine Cooling Fan Assembly **620-5601**



Make:	Isuzu
Applications:	NPR, NPR-HD 1994 - 2008
Position:	
Notes:	
OE Number:	8973838080

GM / ISUZU / WORKHORSE

Engine Harmonic Balancer – Exterior Door Handle

Engine Harmonic Balancer	594-5600
	
Make:	Chevrolet, GMC
Applications:	B60, B6000, C5000 Topkick, C5500 Kodiak, C60, C60 Kodiak, C6000, C6000 Topkick, C70, C70 Kodiak, C7000, C7000 Topkick, P60, P600, P6000, P65, P6500, P6T042, S7, S70, S700, S7000, S7500, S7T042 1983 - 1990
Position:	
Notes:	V8 366CID 6.0L, 6.0L (366 CID) V8 Engine
OE Number:	10106421, 10114166

Engine Oil Cooler Line Connector	800-5602
	
Make:	Chevrolet, GMC
Applications:	C4500 Kodiak, C4500 Topkick, C5500 Kodiak, C5500 Topkick, C6500 Kodiak, C6500 Topkick, C7500 Kodiak, C7500 Topkick, C8500, C8500 Kodiak, C8500 Topkick 2003 - 2009
Position:	
Notes:	Automatic Transmission (MWE); Engine Oil Cooler Line to Engine Block, Engine Oil Cooler Line to Engine Block, Manual Transmission (MWX)
OE Number:	25794270, 15170227

Exhaust Manifold	674-5600
	
Make:	Chevrolet, GMC
Applications:	B7, C6500 Kodiak, C6500 Topkick, C7500 Kodiak, C7500 Topkick 1999 - 2000
Position:	Left; Right
Notes:	V8 454CID 7.4L Includes gaskets, flange studs and nuts
OE Number:	12563000, 12562999

Exhaust Manifold	674-5602
	
Make:	Isuzu
Applications:	NPR, NPR-HD 2003 - 2007
Position:	Right
Notes:	V8 364CID 6.0L (5967cc)
OE Number:	8126037390, 12603739, 12570670, 8125706700

Exhaust Manifold	674-5603
	
Make:	Isuzu
Applications:	NPR, NPR-HD 2003 - 2007
Position:	Left
Notes:	V8 364CID 6.0L (5967cc)
OE Number:	8125706710, 12570671, 8126037370, 12603737

Exterior Door Handle	760-5601
	
Make:	Isuzu
Applications:	NPR, NPR-HD 1994 - 2001
Position:	Front Left
Notes:	Black
OE Number:	8978521074, 8978677211, 8978521075, 8978677210

Exterior Door Handle	760-5602
	
Make:	Isuzu
Applications:	NPR, NPR-HD 1994 - 2001
Position:	Front Right
Notes:	Black
OE Number:	8978677220, 8978521085, 8978677221, 8978521084

Exterior Door Handle	760-5603
	
Make:	Chevrolet, GMC
Applications:	C3500HD, C4500 Kodiak, C5000 Topkick, C5500 Kodiak, C60 Kodiak, C6000 Topkick, C6500 Kodiak, C6500 Topkick, C70 Kodiak, C7000 Topkick, C7500 Kodiak, C7500 Topkick 1990 - 2002
Position:	Front Right
Notes:	Black; w/Zinc Finish
OE Number:	15619625

Exterior Door Handle	760-5604
	
Make:	Chevrolet, GMC
Applications:	C3500HD, C4500 Kodiak, C5000 Topkick, C5500 Kodiak, C60 Kodiak, C6000 Topkick, C6500 Kodiak, C6500 Topkick, C70 Kodiak, C7000 Topkick, C7500 Kodiak, C7500 Topkick 1990 - 2002
Position:	Front Left
Notes:	Black; w/Zinc Finish
OE Number:	15619624

Exterior Door Handle	760-5605
	
Make:	Chevrolet, GMC
Applications:	C4500 Kodiak, C4500 Topkick, C5500 Kodiak, C5500 Topkick, C6500 Kodiak, C6500 Topkick, C7500 Kodiak, C7500 Topkick, C8500, C8500 Kodiak, C8500 Topkick, Kodiak C8500, Topkick C8500 2003 - 2009
Position:	Right
Notes:	Black and Chrome
OE Number:	15032458, 20830534, 15165610, 15174845, 15827690, 25833689, 25862355

Exterior Door Handle	760-5606
	
Make:	Chevrolet, GMC
Applications:	C4500 Kodiak, C4500 Topkick, C5500 Kodiak, C5500 Topkick, C6500 Kodiak, C6500 Topkick, C7500 Kodiak, C7500 Topkick, C8500, C8500 Kodiak, C8500 Topkick, Kodiak C8500, Topkick C8500 2003 - 2009
Position:	Left
Notes:	Black and Chrome
OE Number:	20830535, 15174844, 25833719, 15827689, 15032457, 15165609, 25862356

Exterior Door Handle	760-5607
	
Make:	Isuzu
Applications:	NPR, NPR-HD, NQR, NRR 2007 - 2016
Position:	Front Left
Notes:	Black
OE Number:	8980371001, 8980371002, 98037100

GM / ISUZU / WORKHORSE

Exterior Door Handle – Windshield Wiper Linkage

Exterior Door Handle 760-5608



Make:	Isuzu
Applications:	NPR, NPR-HD, NQR, NRR 2007 - 2016
Position:	Front Right
Notes:	Black
OE Number:	98037101, 8980371011, 8980371012

Interior Door Handle 761-5600



Make:	Chevrolet, GMC
Applications:	C3500HD, C5000 Topkick, C5500 Kodiak, C60 Kodiak, C6000 Topkick, C6500 Kodiak, C6500 Topkick, C70 Kodiak, C7000 Topkick, C7500 Kodiak, C7500 Topkick 1990 - 2002
Position:	Front Left
Notes:	Black and Chrome
OE Number:	22071935, 22086873

Interior Door Handle 761-5601



Make:	Chevrolet, GMC
Applications:	C3500HD, C5000 Topkick, C5500 Kodiak, C60 Kodiak, C6000 Topkick, C6500 Kodiak, C6500 Topkick, C70 Kodiak, C7000 Topkick, C7500 Kodiak, C7500 Topkick 1990 - 2002
Position:	Front Right
Notes:	Black and Chrome
OE Number:	22071936, 22086874

Power Steering Pump Pulley 300-5600



Make:	Chevrolet, GMC
Applications:	B60, B7, C50, C5000 Topkick, C5500 Kodiak, C60, C60 Kodiak, C6000 Topkick, C6500 Kodiak, C70, C70 Kodiak, C7000 Topkick, C7500 Kodiak, P60, P6000, P65, P6500, S7, S70, S700, S7000, S7500, T5500, T6500, T7500, T8500 1983 - 2000
Position:	
Notes:	
OE Number:	2477954

Turn Signal Light Assembly 888-5605



Make:	Isuzu
Applications:	NPR, NPR-HD, NQR, NRR 2006 - 2007
Position:	Front Right
Notes:	Includes Bulbs
OE Number:	8980108930

Turn Signal Light Assembly 888-5606



Make:	Isuzu
Applications:	NPR, NPR-HD, NQR, NRR 2006 - 2007
Position:	Front Left
Notes:	Includes Bulbs
OE Number:	8980108940

Washer Fluid Reservoir 603-5602



Make:	Isuzu
Applications:	NPR, NPR-HD, NQR, NRR 1996 - 2010
Position:	
Notes:	Includes caps, pump, and level sensors (where applicable)
OE Number:	897855656

Window Crank Handle 775-5600



Make:	Chevrolet, Isuzu
Applications:	FRR, FSR, FTR, FVR, T6500, T7500, T8500 1997 - 2009
Position:	
Notes:	Black
OE Number:	8943714270

Window Crank Handle 775-5601



Make:	GMC, Isuzu
Applications:	NPR, NPR-HD, T6500, T7500, T8500 1997 - 2015
Position:	
Notes:	Front Door; Dark Gray
OE Number:	8970984530

Window Crank Handle 775-5602



Make:	Chevrolet, GMC
Applications:	C3500HD, C4500 Kodiak, C5500, C5500 Kodiak, C60 Kodiak, C6000 Topkick, C6500, C6500 Kodiak, C6500 Topkick, C70 Kodiak, C7000 Topkick, C7500 Kodiak, C7500 Topkick, C8500 1995 - 2002
Position:	
Notes:	Gray Handle; w/Black Knob
OE Number:	15692241

Window Crank Handle 775-5603



Make:	Chevrolet, GMC
Applications:	C4500 Kodiak, C4500 Topkick, C5500, C5500 Kodiak, C5500 Topkick, C6500 Kodiak, C6500 Topkick, C7500 Kodiak, C7500 Topkick, C8500, C8500 Kodiak, C8500 Topkick, Express 4500, Savana 4500 2003 - 2015
Position:	
Notes:	Dark Gray
OE Number:	21097404

Windshield Wiper Linkage 602-5601



Make:	Isuzu
Applications:	NPR, NPR-HD, NQR 1995 - 2011
Position:	
Notes:	
OE Number:	897855152, 8941655400, 8941654621, 8978551540

HINO

Engine Coolant Reservoir – Washer Fluid Reservoir

Engine Coolant Reservoir	603-5751
	
Make:	Hino
Applications:	145, 165, 185, 238, 258ALP, 258LP, 268, 268A, 308, 338, 338CT, 358, Dutro, FD 2005 - 2010
Position:	
Notes:	Includes caps, pump, and level sensors (where applicable)
OE Number:	16470E0030

Exterior Door Handle	760-5750
	
Make:	Hino
Applications:	238, 258ALP, 258LP, 268, 268A, 338 2009 - 2014
Position:	Front Left, Front Right
Notes:	Black
OE Number:	S691101241

Headlight Assembly	888-5759
	
Make:	Hino
Applications:	145, 165, 185, 258ALP, 258LP, 268, 268A, 338, 338CT 2006 - 2014
Position:	Right
Notes:	Includes bulbs
OE Number:	9H19460250

Headlight Assembly	888-5760
	
Make:	Hino
Applications:	145, 165, 185, 258ALP, 258LP, 268, 268A, 338, 338CT 2006 - 2014
Position:	Left
Notes:	Includes bulbs
OE Number:	9H19460250

Washer Fluid Reservoir	603-5752
	
Make:	Hino
Applications:	145, 165, 185, 238, 258ALP, 258LP, 268, 268A, 308, 338, 338CT, 358, Dutro, FD 2005 - 2010
Position:	
Notes:	Includes caps, pump, and level sensors (where applicable)
OE Number:	85310E0020

HD EGR VALVE & COOLERS

Heavy Duty Exhaust Gas Recirculation Coolers

- Dorman HD Solutions' EGR Coolers are quality-engineered to cool exhaust gas and recirculate it back to engine
- Complete Kits include all gaskets and hardware allowing for a complete repair



904-5001
Cummins ISX 2007-03



904-5035
Cummins ISX 2007-03



904-5021
Volvo D12 2007-03



Growing the size of the
HEAVY DUTY
A f t e r m a r k e t

SPECIALTY COVERAGE

Caterpillar.....	84
Cummins.....	86
Detroit Diesel.....	89
Eaton.....	90
Refuse.....	91
School Bus, Thomas Bus / Freightliner.....	97
School Bus, International.....	99

CATERPILLAR

Engine Camshaft Position Sensor – Manifold Absolute Pressure Sensor

Engine Camshaft Position Sensor 904-7017



Make:	Caterpillar
Applications:	Caterpillar C15 engines 2004 - 2005
Position:	Center Upper
Notes:	
OE Number:	2016617

Engine Coolant Temperature Sensor 904-7039



Make:	Caterpillar
Applications:	Caterpillar 3406 engines 1994 - 1997
Position:	
Notes:	
OE Number:	1022240

Engine Crankshaft Position Sensor 904-7020



Make:	Caterpillar
Applications:	Caterpillar 3126BTA6 engines 2002 - 2003
Position:	Rear Left Rearward
Notes:	
OE Number:	1693300, 1194142, 2454630

Engine Crankshaft Position Sensor 904-7021



Make:	Caterpillar
Applications:	Caterpillar C11 engines 2004 - 2006
Position:	Rear Left
Notes:	
OE Number:	2016615

Engine Crankshaft Position Sensor 904-7024



Make:	Caterpillar
Applications:	Caterpillar C15 engines 2003 - 2004
Position:	Rear
Notes:	
OE Number:	1918303

Engine Oil Pressure Sensor 904-7012



Make:	Caterpillar
Applications:	Caterpillar 3126 engines 1999 - 2000
Position:	
Notes:	
OE Number:	2244536, 1946726

Engine Oil Pressure Sensor 904-7016



Make:	Caterpillar
Applications:	Caterpillar C10 engines 1998 - 1999
Position:	
Notes:	
OE Number:	1619930, 3E7570, 1112350

Engine Oil Pressure Sensor 904-7027



Make:	Caterpillar
Applications:	Caterpillar C15 engines 2004 - 2005
Position:	
Notes:	
OE Number:	1946725

Exhaust Manifold 674-5002



Make:	Caterpillar
Applications:	Caterpillar C16 engines 2001 - 2004
Position:	Includes gaskets and hardware
Notes:	
OE Number:	1501914, CT1333359

Fuel Pressure Sensor 904-7018



Make:	Caterpillar
Applications:	Caterpillar C15 engines 2006 - 2008
Position:	
Notes:	
OE Number:	2842728, 2482168

Fuel Pressure Sensor 904-7029



Make:	Caterpillar
Applications:	Caterpillar C7 engines 2005 - 2007
Position:	
Notes:	
OE Number:	2482169

Manifold Absolute Pressure Sensor 904-7033



Make:	Caterpillar
Applications:	Caterpillar C12 engines 2000 - 2000
Position:	Manifold
Notes:	
OE Number:	1946724, 1619929

Manifold Absolute Pressure Sensor 904-7037



Make:	Caterpillar
Applications:	Caterpillar C11 engines 2003 - 2006
Position:	Manifold
Notes:	
OE Number:	2393478

Sensor - Auto Transmission Speed 904-7026



Make:	Caterpillar
Applications:	Caterpillar C11 engines 2004 - 2006
Position:	Input
Notes:	
OE Number:	2016616

Turbocharger Boost Sensor 904-7015



Make:	Caterpillar
Applications:	Caterpillar 3126 engines 1995 - 1996
Position:	
Notes:	Outlet
OE Number:	1619927, 1414120, 3E6379, 1112351, 1212728

Turbocharger Boost Sensor 904-7028



Make:	Caterpillar
Applications:	Caterpillar 3126 engines 1997 - 1998
Position:	
Notes:	Inlet
OE Number:	1414119, 1946722, 1619925



Avoid CSA points by easily replacing cracked or leaking reservoirs.

DORMAN HD SOLUTIONS FLUID RESERVOIRS FEATURE THE FOLLOWING BENEFITS:

- #1 IN AFTERMARKET COVERAGE, OFFERING THE MOST EXCLUSIVE SKUS
- ALL RESERVOIRS INCLUDE CAPS AND SENSORS (WHERE APPLICABLE)



CLEAR DESIGN
ELIMINATES NEED
FOR LEAK PRONE
SIGHT GAUGES

PROBLEM

RESERVOIRS TEND
TO LEAK FROM
THE SIGHT HOLES



SOLUTION

CLEAR DESIGN
EASILY MAKES
FLUID VIEWABLE



CUMMINS

Diesel Particulate Filter Clamp – EGR Valve

Diesel Particulate Filter Clamp		674-9000
		
Make:	Cummins	
Applications:	Cummins ISX Engines 2007 - 2015	
Position:		
Notes:	w/2007 & 2010 EPA Standards	
OE Number:	21445455	

EGR Cooler		904-5035
		
Make:	Cummins	
Applications:	Cummins ISX 15 2003 - 2007	
Position:		
Notes:	Includes all gaskets and hardware	
OE Number:	2881783, 3682986, 4089436, 3683435, 4952490, 4956008NX, 4089166, 4956008, 2881783NX, 3683253, 2878071, 3683069, 2869133, 3682806	

EGR Cooler		904-5036
		
Make:	Cummins	
Applications:	ISM 10.8, ISM 10.8, ISM 10.8, ISM 10.8 2003 - 2007	
Position:		
Notes:	Includes all gaskets and hardware	
OE Number:	4089380, 3102803, 4089380NX	

EGR Cooler Gasket Kit		904-5007
		
Make:	Cummins	
Applications:	Cummins Gen 1 ISX 15.0, ISX 15.0, CL700 SubModel, ISX-400, ISX-450, ISX-475, ISX-500, ISX-565, ISX-600 2003 - 2007	
Position:		
Notes:	Includes all gaskets and hardware	
OE Number:	4309434NX	

EGR Cooler Gasket Kit		904-5008
		
Make:	Cummins	
Applications:	ISX 15.0, ISX-400, ISX-450, ISX-475, ISX-500, ISX-565, ISX-600 2007 - 2010	
Position:		
Notes:	Generation 2, Includes all gaskets and hardware	
OE Number:	2881784, 4309398, 4309248, 4309248NX, 4955467, 3684448, 2881747, 2881784NX, 2881747NX, 4955926, 4309398NX	

EGR Cooler Gasket Kit		904-5009
		
Make:	Cummins	
Applications:	Cummins ISX 11.9, ISX 15 2010 - 2011	
Position:		
Notes:	Includes all gaskets and hardware	
OE Number:	4309491NX	

EGR Cooler Gasket Kit		904-5010
		
Make:	Cummins	
Applications:	Cummins ISM 2002 - 2006	
Position:		
Notes:	Generation 1, Includes all gaskets and hardware	
OE Number:	4089380NX	

EGR Cooler Gasket Kit		904-5011
		
Make:	Cummins	
Applications:	Cummins ISM 10.8 2007 - 2010	
Position:		
Notes:	Generation 2, Includes all gaskets and hardware	
OE Number:	2881725NX	

EGR Cooler Gasket Kit		904-5012
		
Make:	Cummins	
Applications:	ISB 5.9, ISB E-175, ISB E-190, ISB E-195, ISB E-210, ISB 2002 - 2006	
Position:		
Notes:	Includes all gaskets and hardware	
OE Number:	4089256NX	

EGR Cooler Gasket Kit		904-5013
		
Make:	Cummins	
Applications:	ISB 200, ISB 5.9, ISB, ISB6.7-200, ISB6.7-220, ISB6.7-240, ISB6.7-260, ISB6.7-280 2007 - 2010	
Position:		
Notes:	Includes all gaskets and hardware	
OE Number:	4955518NX	

EGR Pressure Feedback Sensor		904-5052
		
Make:	Cummins	
Applications:	Cummins ISB 2006 - 2014	
Position:	Exhaust Gas Temperature	
Notes:	2007 and 2010 EPA Emission Standard	
OE Number:	4928594, 4921746	

EGR Valve		904-5001
		
Make:	Cummins	
Applications:	Cummins ISX 2003 - 2007	
Position:		
Notes:	Fits Engines Manufactured From 09/31/2002, Generation 1, Includes all gaskets and mounting hardware	
OE Number:	4955422RX, 3683305, 3682974, 3682954, 3104874, 3682805, 4955422, 4955422NX, 3684004, 3683446	

EGR Valve **904-5002**



Make:	Cummins
Applications:	Cummins ISM 2003 - 2007
Position:	
Notes:	Fits Engines Manufactured From 09/31/2002, Generation 1, Includes all gaskets and mounting hardware
OE Number:	4921905, 3104875, 4955421, 3103765, 4955421RX, 3103824, 3103361, 2102745

Engine Camshaft Position Sensor **904-7129**



Make:	Cummins
Applications:	Cummins ISB 1998-2001
Position:	
Notes:	
OE Number:	4921597

Engine Coolant Pipe **936-5401**



Make:	Cummins
Applications:	N14 1990 - 1996
Position:	Lower
Notes:	Stainless
OE Number:	0706464

Engine Crankshaft Position Sensor **904-7123**



Make:	Cummins
Applications:	Cummins ISB 5.9 1998 - 2001
Position:	Front
Notes:	
OE Number:	4921601

Engine Oil Dipstick **917-5501**



Make:	Cummins
Applications:	ISX 15.0 2006 - 2015
Position:	
Notes:	Dipstick Only
OE Number:	20576425

Engine Oil Dipstick **917-5502**



Make:	Cummins
Applications:	ISX 15.0 2006 - 2015
Position:	
Notes:	Dipstick w/Tube
OE Number:	21500943

Engine Oil Drain Plug **090-5002**



Make:	Cummins
Applications:	Cummins ISL, L10 engines 1974 - 2014
Position:	
Notes:	
OE Number:	3055069

Engine Oil Drain Plug **090-5003**



Make:	Cummins
Applications:	Cummins ISX 11.9, ISX 11.9G, ISX 15.0 1998 - 2015
Position:	
Notes:	
OE Number:	4926565

Engine Oil Drain Plug Gasket **095-5002**



Make:	Cummins
Applications:	Cummins ISL, L10 Engines 1981 - 2010
Position:	
Notes:	
OE Number:	67946

Engine Oil Drain Plug Gasket **095-5003**



Make:	Cummins
Applications:	Cummins ISX 11.9, ISX 15.0 1998 - 2015
Position:	
Notes:	
OE Number:	3678606

Engine Oil Pressure Sensor **904-5050**



Make:	Cummins
Applications:	Cummins ISX 11.9, ISX 11.9G, ISX 15.0, ISX 2004 - 2016
Position:	
Notes:	
OE Number:	4921517

Engine Oil Pressure Sensor **904-7109**



Make:	Cummins
Applications:	Cummins ISX engines 2000 - 2003
Position:	
Notes:	
OE Number:	4921475

CUMMINS

Engine Oil Pressure Sensor – Turbocharger Speed Sensor

Engine Oil Pressure Sensor 904-7241



Make:	Cummins
Applications:	Cummins ISM 10.8 engines 2000 - 2002
Position:	
Notes:	
OE Number:	4921477

Manifold Absolute Pressure Sensor 904-7107



Make:	Cummins
Applications:	Cummins ISX 15 engines 2002 - 2006
Position:	Manifold
Notes:	
OE Number:	4928593

Manifold Absolute Pressure Sensor 904-7124



Make:	Cummins
Applications:	ISB 5.9 1999 - 2002
Position:	Manifold
Notes:	
OE Number:	4921497

Manifold Absolute Pressure Sensor 904-7142



Make:	Cummins
Applications:	Cummins ISX 15 engines 2000 - 2000
Position:	
Notes:	
OE Number:	4921473

Turbocharger Boost Pressure Valve 599-5001



Make:	Cummins
Applications:	Cummins ISM 10.8, ISX 15 2005 - 2007
Position:	
Notes:	Remanufactured
OE Number:	3770742, 4037440, 4039813, 4046304, 2836554, 4040589, 4036195

Turbocharger Speed Sensor 904-7111



Make:	Cummins
Applications:	Cummins ISX 11.9, ISX 15 2010 - 2011
Position:	
Notes:	2010 EPA Standard
OE Number:	4032173

Turbocharger Speed Sensor 904-7139



Make:	Cummins
Applications:	ISB 200, ISB 6.7, ISB6.7, ISB6.7-200, ISB6.7-220, ISB6.7-240, ISB6.7-260, ISB6.7-280 2009 - 2010
Position:	
Notes:	
OE Number:	4032315

Turbocharger Speed Sensor 904-7146



Make:	Cummins
Applications:	ISB 200, ISB 6.7, ISB6.7, ISB6.7-200, ISB6.7-220, ISB6.7-240, ISB6.7-260, ISB6.7-280 2011 - 2016
Position:	
Notes:	
OE Number:	4032806

HAVE A TECHNICAL QUESTION?

Our certified technicians have the answers. Call us at:

800-868-5777 x5501

DormanHDSolutions.com

Engine Coolant Pipe	936-5201
	
Make:	Detroit Diesel
Applications:	Detroit Diesel Series 60 Engines 1999 - 2010
Position:	Lower
Notes:	Stainless
OE Number:	A051638000

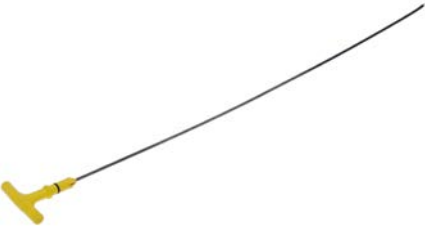
Engine Oil Dipstick	917-5201
	
Make:	Detroit Diesel
Applications:	Detroit Diesel Series 60 Engines 2008 - 2011
Position:	
Notes:	
OE Number:	23534354

Engine Oil Drain Plug	090-5004
	
Make:	Detroit Diesel
Applications:	Detroit Diesel Series 60 Engines 1987 - 2015
Position:	
Notes:	
OE Number:	23505720

Throttle Body Motor	341-5001
	
Make:	Detroit Diesel
Applications:	Detroit Diesel DD13, DD15, DD16, DD60 series engines 1987 - 2015
Position:	
Notes:	Remanufactured
OE Number:	RA46009000, A460098031, A460098021

Turbocharger Boost Sensor	904-7254
	
Make:	Detroit Diesel
Applications:	Detroit Diesel Series 60 Engines 2007 - 2007
Position:	
Notes:	
OE Number:	23527829



Heavy Duty Exhaust Gas Recirculation Coolers

DORMAN HD SOLUTIONS EGR PRODUCTS FEATURE THE FOLLOWING BENEFITS:

- MANUFACTURED SPECIFICALLY FOR DIESEL VEHICLES, DORMAN'S EGR COOLERS ARE QUALITY ENGINEERED TO COOL EXHAUST GAS AND RECIRCULATE IT BACK TO THE ENGINE

– KITS INCLUDE ALL GASKETS AND HARDWARE FOR A COMPLETE REPAIR



EATON

Air Shift Knob

Air Shift Knob 455-5001



Make:	Eaton
Applications:	All FR, FRO, RT, RTO Series 8, 9 and 10 Speeds
Position:	
Notes:	
OE Number:	A-5010, A-6909

Air Shift Knob 455-5002



Make:	Eaton
Applications:	All RT, RTLO Series 13 Speeds
Position:	
Notes:	
OE Number:	A-6913, A-4900

Air Shift Knob 455-5003



Make:	Eaton
Applications:	All RT, RTO Series 8LL, 15 Speeds and 6613 Models
Position:	
Notes:	
OE Number:	A-6915, A-5015

Air Shift Knob 455-5004



Make:	Eaton
Applications:	RTLO-XX610 A and B Models (Super 10)
Position:	
Notes:	
OE Number:	A-6910, A-5510

Air Shift Knob 455-5005



Make:	Eaton
Applications:	18 Speed Models
Position:	
Notes:	
OE Number:	A-6918, A-5013

Air Shift Knob 455-5007



Make:	Eaton
Applications:	Supply Ports (2), 1/8 NPT, Delivery Ports (3), 1/8 NPT, Control Port (1) 1/8 NPT
Position:	
Notes:	
OE Number:	A5000

Air Shift Knob 455-5008



Make:	Eaton
Applications:	RTO-9513, 12513 Model w/ 3-Position Selector
Position:	
Notes:	
OE Number:	A-4487

Air Shift Knob 455-5009



Make:	Eaton
Applications:	RTO-9513 & 12513 Model w/ 2-Position Selector
Position:	
Notes:	
OE Number:	A-4491

Air Shift Knob 455-5010



Make:	Eaton
Applications:	High/Low Range Valve w/o air fittings
Position:	
Notes:	
OE Number:	A3546



Growing the size of the
HEAVY DUTY
A f t e r m a r k e t



REFUSE

Dorman HD Solutions offers a number of aftermarket solutions for the highest in-demand products for Refuse vehicles.

Our coverage includes over 50 Part Numbers covering over 20 Categories.

REFUSE

Accelerator Pedal – Fuel Tank Sending Unit

Accelerator Pedal	699-5501
	
Make:	Mack
Applications:	MRU 2010 - 2016
Position:	
Notes:	
OE Number:	82734051, 21915482

Cab Door Vent	242-5503
	
Make:	Mack
Applications:	MR, MRU 1981 - 2014
Position:	Left
Notes:	Black, Paintable
OE Number:	25161633

Console Multi Function Switch	978-5502
	
Make:	Mack
Applications:	DM, MR, MRU 1986 - 2015
Position:	
Notes:	Black
OE Number:	1MR571

Diesel Emissions Fluid Filler Cap	904-5501
	
Make:	Mack
Applications:	CHU, CXU, GU7, GU8, LEU, MRU, Pinnacle, TD700 2009 - 2013
Position:	
Notes:	Non-Locking
OE Number:	21148728

Engine Coolant Level Sensor	924-5506
	
Make:	Mack
Applications:	CV, GU7, GU8 2004 - 2008
Position:	
Notes:	
OE Number:	25174715, 64MT466

Engine Oil Dipstick	917-5505
	
Make:	Mack
Applications:	LEU with MP7 engine 2008 - 2010
Position:	
Notes:	Dipstick w/Tube
OE Number:	21500925, MK21500925

Engine Oil Dipstick	917-5507
	
Make:	Mack
Applications:	CH, CL, DM, DMM, LE, MR, RB, RD, Vision, E7 engines 1990 - 2000
Position:	
Notes:	Dipstick Only
OE Number:	795GB373P7

Engine Oil Dipstick	917-5508
	
Make:	Mack
Applications:	CH, CL, CV, DM, DMM, LE, MH, MR, R, RB, RD, RM, RW, E7 engines 1989 - 2005
Position:	
Notes:	Dipstick Only
OE Number:	795GB377A

Exterior Door Handle	760-5203
	
Make:	Freightliner
Applications:	Condor 2003 - 2005 Condor
Position:	Front Left
Notes:	Black and Chrome
OE Number:	A184222800

Exterior Door Handle	760-5204
	
Make:	Freightliner
Applications:	Condor 2003 - 2005 Condor
Position:	Front Right
Notes:	Black and Chrome
OE Number:	A184222800

Exterior Door Handle	760-5501
	
Make:	Mack
Applications:	LE 1997 - 2007
Position:	Front Left
Notes:	Black
OE Number:	25192012, 20QX415M

Fuel Tank Sending Unit	285-5503
	
Make:	Mack
Applications:	DM, MR 1991 - 2003
Position:	
Notes:	Direct Fit, Models w/Rectangular Tank, Includes gaskets and hardware
OE Number:	16MB48DP13

Fuel Tank Sending Unit 285-5508



Make:	Mack
Applications:	CH, CHU, CL, CS200P Mid-Liner, CS250P Mid-Liner, CS300P Mid-Liner, CS300T Mid-Liner, CV, CXN, CXP, CXU, DM, DMM, GU7, GU8, LE, LEU, MR, MRU, MS200P Mid-Liner, MS250P Mid-Liner, MS300P Mid-Liner, MS300T Mid-Liner, Pinnacle, RB, RD, TD700, Vision 1991 - 2011
Position:	
Notes:	Universal Fit, Includes gaskets and hardware
OE Number:	8609NC2759

Grille 242-5502



Make:	Mack
Applications:	CHU, CXN, CXP, CXU, Pinnacle, Vision 1999 - 2014
Position:	Front
Notes:	Exc. Rawhide Submodel, Includes bug screen and mounting hardware
OE Number:	6MF580M, 20791629, 25166278

Headlight Bezel 889-5503



Make:	Mack
Applications:	RB, RD 1995 - 2000
Position:	Left, Right
Notes:	Single Square Headlight, Black plastic
OE Number:	215161698, 25161698

Hood Hinge Spring 938-5501



Make:	Mack
Applications:	CXN, Vision, CX, CXP 1999 - 2007
Position:	
Notes:	Silver
OE Number:	25171284

Hood Hinge Spring 938-5502



Make:	Mack
Applications:	CH 1999 - 2003
Position:	
Notes:	Silver
OE Number:	25158019

Hood Latch Assembly 315-5502



Make:	Mack
Applications:	CH, Vision 2001 - 2015
Position:	Right
Notes:	Contains all brackets
OE Number:	0055554, 55554, 25169065, 374129560

Hood Latch Assembly 315-5503



Make:	Mack
Applications:	CH, Vision 2002 - 2015
Position:	Left
Notes:	Contains all brackets
OE Number:	25159428

Hood Restraint Cable 924-5501



Make:	Mack
Applications:	CH models with Axle Forward 1990 - 1995
Position:	
Notes:	
OE Number:	25152850

Hood Restraint Cable 924-5502



Make:	Mack
Applications:	RD 1990 - 2000
Position:	
Notes:	
OE Number:	25171452

Tachometer Sensor 505-5504

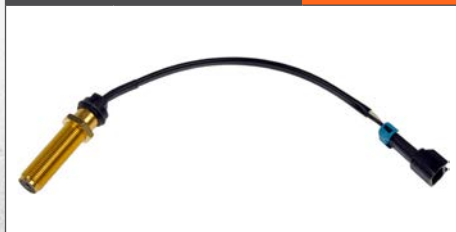

Make:	Mack
Applications:	CH, MR 1990 - 2003
Position:	
Notes:	Magnum 430HP
OE Number:	64MT435

Tilt Cab Lock 315-5520



Make:	Mack
Applications:	LEU, MR, MRU 1991 - 2012
Position:	
Notes:	Left and Right
OE Number:	184QS39301, 233QS44M, 184QS39301, 25152013, 25158598

Truck Cab Side Step 157-5507





Make:	Mack
Applications:	CHU, CV, CXN, CXP, CXU, GU7, GU8, LEU, MRU, Pinnacle, TD700, Vision 2005 - 2011
Position:	
Notes:	63.5 In. Long x 5 In. Wide
OE Number:	85QM4192M6, MK85QM4192

REFUSE

Truck Cab Side Step – Window Crank Handle

Truck Cab Side Step	157-5508
	
Make:	Mack
Applications:	CHU, CV, CXN, CXP, CXU, GU7, GU8, LEU, MRU, Pinnacle, TD700, Vision 2005 - 2011
Position:	
Notes:	62 In. Long x 5 In. Wide
OE Number:	85QM4192M4, 20816521

Truck Cab Side Step	157-5509
	
Make:	Mack
Applications:	CH, CHN, CHU, CL, CT, CTP, CV, CX, CXN, CXP, CXU, DM, GU7, GU8, LE, LEU, MR, MRU, RB, RD, TD700, Vision 2005 - 2011
Position:	
Notes:	21.5 In. Long x 6 In. Wide
OE Number:	25173208

Truck Cab Side Step	157-5510
	
Make:	Mack
Applications:	CHU, CV, CXN, CXP, CXU, GU7, GU8, LEU, MRU, Pinnacle, TD700, Vision 2005 - 2011
Position:	
Notes:	36 In. Long x 5 In. Wide x 2 In. High
OE Number:	85QM4224AM, 25168803

Vehicle Speed Sensor	505-5201
	
Make:	Freightliner
Applications:	Argosy, Cargo, Cascadia, Century, Century 112, Century 120, Classic, Columbia, Condor, Coronado, FC70, FC80, FL106, FL50, FL60, FL70, FL80, FLC 112, FLD 120, FLD120 SD, FS65, M2, M2 106, M2 112, MB 80, MB60, MB70, MT35, MT45, Severe-Duty FLD 1989 - 2011
Position:	
Notes:	w/Merritor Transmission, Screw In Style, w/Internal Tone Ring
OE Number:	

Vehicle Speed Sensor	505-5505
	
Make:	Mack
Applications:	CHU, CHN, CL, CV, CXP, DM, CXU, GU7, GU8, LEU, MRU, Pinnacle, TD700, 1989 - 2010
Position:	
Notes:	w/Eaton Transmission; Screw In Style; 1 Connector w/2 Terminals
OE Number:	25166488

Vehicle Speed Sensor	505-5507
	
Make:	Mack
Applications:	CH, DM, MR, RD 1981 - 1990
Position:	
Notes:	2 Connectors w/2 Terminals Each
OE Number:	64MT412M

Vehicle Speed Sensor	505-5512
	
Make:	Mack
Applications:	CHU, CXU, GU7, GU8, LEU, MRU, Pinnacle, TD700, CV, CH, CHN, CV 1991 - 2011
Position:	
Notes:	1 Connector w/3 Terminals, Push In Style; 1 Connector w/3 Terminals
OE Number:	20706327

Washer Fluid Reservoir	603-5503
	
Make:	Mack
Applications:	MR 1991 - 2003
Position:	
Notes:	Includes caps, pump, and level sensors (where applicable)
OE Number:	25128217

Washer Fluid Reservoir	603-5512
	
Make:	Mack
Applications:	RD 1987 - 2002
Position:	
Notes:	w/Reservoir Located In Passenger Door, Includes caps, pump, and level sensors (where applicable)
OE Number:	25128543

Window Channel	750-5501
	
Make:	Mack
Applications:	MR, MRU 1990 - 2011
Position:	Front Left
Notes:	Manual Regulator
OE Number:	25191519

Window Channel	750-5502
	
Make:	Mack
Applications:	MR, MRU 1990 - 2011
Position:	Front Right
Notes:	w/Manual Windows
OE Number:	25191690

Window Crank Handle	775-5501
	
Make:	Mack
Applications:	CH, CHU, CV, CXP, CXU, GU7, GU8, Pinnacle 1995 - 2009
Position:	Left; Right
Notes:	Black Handle; w/Black Knob
OE Number:	25127753, 2517753, 200X33AM25, 200X33AM

Window Crank Handle	775-5502 ↗
	
Make:	Mack
Applications:	CH, CHU, CV, CXP, CXU, GU7, GU8, Pinnacle 1995 - 2009
Position:	Left; Right
Notes:	Chrome Handle; w/Black Knob
OE Number:	25127752

Window Regulator	740-5501
	
Make:	Mack
Applications:	MR 1991 - 2003
Position:	Front Left
Notes:	Manual Window Regulator; Crank Assembly Portion
OE Number:	25191027

Window Regulator	740-5502
	
Make:	Mack
Applications:	MR 1991 - 2003
Position:	Front Right
Notes:	Manual Window Regulator; Crank Assembly Portion
OE Number:	25191633

Window Regulator	740-5503
	
Make:	Mack
Applications:	MR 1991 - 2003
Position:	Front Left
Notes:	Manual Window Regulator; Scissor Assembly Portion
OE Number:	25113357

Window Regulator	740-5504
	
Make:	Mack
Applications:	MR 1991 - 2003
Position:	Front Right
Notes:	Manual Window Regulator; Scissor Assembly Portion
OE Number:	25114490

Window Regulator	740-5505
	
Make:	Mack
Applications:	RD 1990 - 2000
Position:	Front Left
Notes:	Manual Window Regulator
OE Number:	25161668

Window Regulator	740-5506
	
Make:	Mack
Applications:	RD 1990 - 2000
Position:	Front Right
Notes:	Manual Window Regulator
OE Number:	25160158



Avoid CSA points by easily replacing cracked or hazed lighting assemblies.

DORMAN HD SOLUTIONS LIGHTING PRODUCTS FEATURE THE FOLLOWING BENEFITS:

- ALL DORMAN HD HEADLIGHTS ARE COATED WITH A TWO-COMPONENT, THERMALLY CURED SILICONE HARD COATING, WHICH IS RECOMMENDED BY TMC*
- COATING HELPS PREVENT HEADLIGHT'S SURFACE FROM HAZING

*TECHNOLOGY & MAINTENANCE COUNCIL

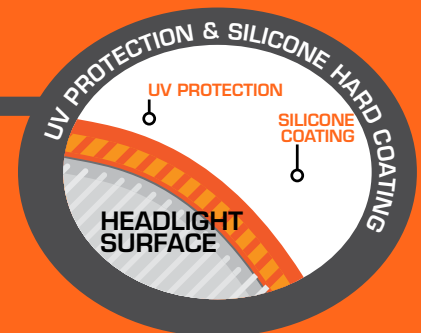



Growing the size of the
HEAVY DUTY
A f t e r m a r k e t





SCHOOL BUS

Dorman HD Solutions offers a number of aftermarket solutions for the highest in-demand products for School Buses.

Our coverage includes International and Freightliner, with over 45 Part Numbers covering over 15 Categories.

SCHOOL BUS, THOMAS BUS, FREIGHTLINER

Diesel Emissions Fluid Filler Cap – Fuel Tank Strap

Diesel Emissions Fluid Filler Cap  **904-5201** 



Make:	Thomas Bus, Freightliner
Applications:	SAF-T-LINER 2010 - 2016
Position:	
Notes:	
OE Number:	04-27757-000

EGR Cooler Gasket Kit  **904-5012**



Make:	Thomas Bus, Freightliner
Applications:	ISB 5.9, ISB E-175, ISB E-190, ISB E-195, ISB E-210, ISB 2002 - 2006
Position:	
Notes:	Includes all gaskets and hardware
OE Number:	4089256NX

EGR Cooler Gasket Kit  **904-5013**



Make:	Thomas Bus, Freightliner
Applications:	ISB 200, ISB 5.9, ISB, ISB6.7-200, ISB6.7-220, ISB6.7-240, ISB6.7-260, ISB6.7-280 2007 - 2010
Position:	
Notes:	Includes all gaskets and hardware
OE Number:	4955518NX

EGR Pressure Feedback Sensor  **904-5052**



Make:	Thomas Bus, Freightliner
Applications:	Cummins ISB 2006 - 2014
Position:	
Notes:	2007 and 2010 EPA Emission Standard
OE Number:	4921746, 4928594

Engine Coolant Reservoir  **603-5201**



Make:	Thomas Bus, Freightliner
Applications:	SAF-T-LINER FS-65 2002 - 2007
Position:	
Notes:	Includes caps, pump, and level sensors (where applicable)
OE Number:	05-23045-000

Engine Coolant Reservoir  **603-5202**



Make:	Thomas Bus, Freightliner
Applications:	SAF-T-LINER C2 2005 - 2011
Position:	
Notes:	Includes caps, pump, and level sensors (where applicable)
OE Number:	0523195001, 0523195000, 2053074000, 0521178000, S20638

Engine Coolant Reservoir  **603-5207**



Make:	Thomas Bus, Freightliner
Applications:	SAF-T-LINER C2 2012-2016
Position:	
Notes:	Includes caps, pump, and level sensors (where applicable)
OE Number:	A0528531000

Engine Coolant Reservoir Cap  **902-5201**





Make:	Thomas Bus, Freightliner
Applications:	SAF-T-LINER C2 2012-2016
Position:	
Notes:	15 PSI
OE Number:	05-20763-001

Engine Coolant Reservoir Cap  **902-5202** 



Make:	Thomas Bus, Freightliner
Applications:	SAF-T-LINER C2 2004 - 2011
Position:	
Notes:	20 PSI
OE Number:	0517223002

Engine Crankshaft Position Sensor  **904-7123**



Make:	Thomas Bus, Freightliner
Applications:	Cummins ISB 5.9 1998 - 2001
Position:	Front
Notes:	
OE Number:	4921601

Fuel Tank Sending Unit  **285-5207**



Make:	Freightliner
Applications:	SAF-T-LINER C2 2002 - 2012
Position:	Front
Notes:	With 25 inch diameter tank, Includes gaskets and hardware
OE Number:	A22-43065-003

Fuel Tank Strap  **578-5201**



Make:	Thomas Bus, Freightliner
Applications:	SAF-T-LINER C2 2003 - 2011
Position:	
Notes:	23" diameter round tanks
OE Number:	A0338910000

SCHOOL BUS, THOMAS BUS, FREIGHTLINER

Grille – Multi Function Switch

Grille  **242-5208**



Make:	Thomas Bus, Freightliner
Applications:	SAF-T-LINER C2 2003 - 2015
Position:	Front
Notes:	Chrome, With mounting hardware and bug screen
OE Number:	A171478700

Headlight Assembly  **888-5203**





Make:	Thomas Bus, Freightliner
Applications:	SAF-T-LINER C2 2003 - 2015
Position:	
Notes:	Includes bulbs
OE Number:	a06-75732-005

Headlight Assembly  **888-5204**





Make:	Thomas Bus, Freightliner
Applications:	SAF-T-LINER C2 2003 - 2015
Position:	
Notes:	Includes bulbs
OE Number:	a06-75732-004

Hood Restraint Cable  **924-5206** 



Make:	Thomas Bus, Freightliner
Applications:	SAF-T-LINER C2 1989 - 2007
Position:	
Notes:	Long
OE Number:	A171208200

Hood Restraint Cable  **924-5207** 





Make:	Thomas Bus, Freightliner
Applications:	SAF-T-LINER C2 1989 - 2007
Position:	
Notes:	Short
OE Number:	A171208100

Hood Spring  **938-5201**





Make:	Thomas Bus, Freightliner
Applications:	SAF-T-LINER C2 1989 - 2007
Position:	
Notes:	Black
OE Number:	A17-12082-000

Multi Function Switch  **978-5201**



Make:	Freightliner
Applications:	SAF-T-LINER C2 2003 - 2015
Position:	
Notes:	Black
OE Number:	A06-36956-002, A0636956003

Multi Function Switch  **978-5210**



Make:	Freightliner
Applications:	SAF-T-LINER FS-65 2002 - 2007
Position:	
Notes:	Shadow Gray, Self Canceling
OE Number:	A06-22743-002

MEDIUM DUTY COVERAGE AVAILABLE



SCHOOL BUS, INTERNATIONAL

Door Seal – Engine Crankshaft Position Sensor

Door Seal 750-5102



Make:	International Bus
Applications:	3200, 4100, 4100 SBA, 4200, 4200LP, 4300, 4300LP, 4400, 4400LP, 7300, 7300 SBA, 7300 SFA, 7400, 7500, 7600, 7700, 8500, 8500 SBA, 8600, 8600 SBA, CXT, LoneStar, MXT, ProStar, RXT, TerraStar 1990 - 2014
Position:	Left
Notes:	Primary Door Seal
OE Number:	3508972C6

EGR Cooler 904-5020



Make:	International Bus
Applications:	International DT466, DT570, HT570 2004 - 2009
Position:	
Notes:	Round Cooler; 11.5 Inches Long, Includes all gaskets and hardware
OE Number:	1871733C95, 1871733C93, 1871733C92

EGR Cooler 904-5023

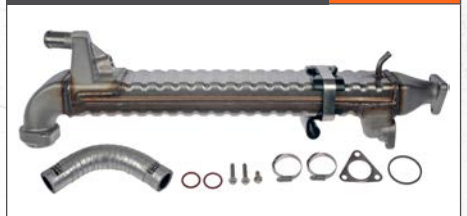

Make:	International Bus
Applications:	International DT466, DT570, HT570 2004 - 2009
Position:	
Notes:	Square Cooler; 21 Inches Long, Includes all gaskets and hardware
OE Number:	1832542C94, 1832542C93, 1832542C91, 1832542C92

EGR Valve 904-5056



Make:	International Bus
Applications:	Maxxforce DT engines 2007-2010
Position:	
Notes:	2007 EPA standard, Includes gaskets and hardware
OE Number:	1878918C1, 1873842C92, 1878918C2, 1875808C1

EGR Valve 904-5062



Make:	International Bus
Applications:	International DT466 2004 - 2016
Position:	
Notes:	Exc. 2003 EPA Standard, Includes gaskets and hardware
OE Number:	1842593C92, 1842593C91

Engine Coolant Reservoir 603-5101



Make:	International Bus
Applications:	3800, 3800 CE, 4700, 4700LP, 4700LPX, 4800, 4900 1995 - 2004
Position:	
Notes:	Includes caps, pump, and level sensors (where applicable)
OE Number:	2002105C2, 5C4Z8A080A, 2002105C3

Engine Coolant Reservoir 603-5104



Make:	International Bus
Applications:	3200, 4100, 4100 SBA, 4200, 4200LP, 4300, 4300LP, 4400, 7300, 7300 SBA, 7300 SFA, 8500, 8500 SBA, 8500 TranStar, CE 1990 - 2016
Position:	
Notes:	Includes caps, pump, and level sensors (where applicable), w/ dual vacuum ports
OE Number:	2602943C91

Engine Coolant Reservoir 603-5110



Make:	International Bus
Applications:	1300, 3200, 3300, 4100, 4100 SBA, 4200, 4200LP, 4300, 4300LP, 4400, 4400LP, 8500, 8500 SBA, 8500 TranStar, BE, CE, F650 1990 - 2016
Position:	Front
Notes:	1 port, Includes caps, pump, and level sensors (where applicable)
OE Number:	2602872C91, 2599039C91, 3578833C3, 4C4Z8B379A, 2602935C91, BC4Z8A080A, 2587324C1, 2591625C92, 2039390C3

Engine Coolant Reservoir Cap 902-5101



Make:	International Bus
Applications:	2000, 2554, 4100, 4200, 4200LP, 4300, 4300LP, 4400, 4400LP, 4700, 4700LP, 4700LPX, 4800, 4900 2002 - 2008
Position:	
Notes:	10 PSI
OE Number:	2039390C3, 4C4Z8100A

Engine Coolant Reservoir Cap 902-5102



Make:	International Bus
Applications:	9200, 9200i SBA, 9400, 9900i, 9900i SFA, 9900ix, 9900ix SFA 2003 - 2010
Position:	
Notes:	15 PSI
OE Number:	4C4Z8100B, 3578833C3, 3578833C2

Engine Coolant Temperature Sensor 505-5101



Make:	International Bus
Applications:	International DT466 1989 - 2000
Position:	
Notes:	
OE Number:	1675751C1, 4C407H141B

Engine Crankshaft Position Sensor 904-7516



Make:	International Bus
Applications:	International MaxxForce 13, V8 363CID 6.0L, V8 365CID 6.0L, V8 391CID 6.4L (6400cc) 2004 - 2015
Position:	
Notes:	
OE Number:	1828345C91, 3C3Z6C315A, DY985

SCHOOL BUS, INTERNATIONAL

Engine Oil Cooler – Headlight Bezel

Engine Oil Cooler  **904-5101**



Make:	International Bus
Applications:	1300 FBC, 3000 Chassis, 3000 IC, CE Commercial, CE Integrated, FE Commercial, FE Integrated, FE School Bus, RE Commercial, RE School Bus 2006 - 2009
Position:	
Notes:	Includes Gaskets and Hardware
OE Number:	1842417C93, 1842418C3, 1842417C94, 1842417C92, 1842530C93, 1842417C91

Engine Oil Pressure Sensor  **904-7512**



Make:	International Bus
Applications:	International VT365 engines 2002 - 2012
Position:	
Notes:	
OE Number:	1872556C91, 1834538C91, 1839415C91

Exhaust Backpressure Sensor  **904-7522**





Make:	International Bus
Applications:	International VT365, V8 365CID 6.0L, VT365 2005 - 2010
Position:	
Notes:	
OE Number:	5C3Z9J460B, 1850352C2, 1850352C1, 5C3Z9J460A

Exhaust Backpressure Sensor  **904-7523**



Make:	International Bus
Applications:	International DT466 2008 - 2013
Position:	
Notes:	
OE Number:	1846480C2

Fuel Tank Sending Unit  **285-5104**



Make:	International Bus
Applications:	1652SC, 1652UPS, 3000, 3000RE, 3200, 3300, 3300 CE, 3400, 3600, 3800, 3800 CE, 3900, 4700, 4700LP, 4700LPX, 4800, 4900, 5000, 5500i, 8100 1997 - 2015
Position:	
Notes:	w/15 In. Deep Tank, Includes gaskets and hardware
OE Number:	476846C1, 476846C2

Fuel Tank Sending Unit  **285-5105**



Make:	International Bus
Applications:	1452SC, 1652SC, 1652UPS, 2000, 2554, 2654, 3700, 3800, 3800 CE, 3900FC, 4600, 4600LP, 4600UH, 4700, 4700LP, 4800, 4900, 7100, 8000, 9370, 9600, Cargostar, COF5870 Paystar, F1954, G1954, M1400 Metro II, M1600 Metro II, S1654, S1654LP, S1723, S1753, S1754, 1985 - 1991
Position:	
Notes:	Direct fit, Includes gaskets and hardware
OE Number:	497840C95, 497840C96, 497840C94

Fuel Tank Strap  **578-5102**



Make:	International Bus
Applications:	All International models with 50 and 60 gallon square tanks 1997 - 2011
Position:	
Notes:	50 and 60 gallon square tanks
OE Number:	471453C2

Grille  **242-5107**



Make:	International Bus
Applications:	3200, 4100, 4100 SBA, 4200, 4200LP, 4300, 4400, 4400LP, 7300, 7300 SFA, 7400, 8500, 8500 SBA, RXT 1990 - 2016
Position:	Front
Notes:	Chrome, Includes mounting clips
OE Number:	3551015C98, 3551015C92, 3551015C95, 3551015C94, 3551015C97, 3551015C96, 3551015C91, 3551015C99, 3551015C93

Headlight Adjusting Screw  **924-5104** 



Make:	International Bus
Applications:	3800 CE, 9400, ProStar, S1723, S1724, S1753, S1754, S1800, S2100, S2155, S2276 1984 - 2009
Position:	
Notes:	
OE Number:	500565C91

Headlight Assembly  **888-5109**



Make:	International Bus
Applications:	3300, 4400, 8600, 8600 SBA 2007 - 2011
Position:	Right
Notes:	Includes Bulbs; wo/Marker Light
OE Number:	3565430C92, 4020417C91, 3565430C93, 3565430C91

Headlight Assembly  **888-5110**



Make:	International Bus
Applications:	3300, 4400, 8600, 8600 SBA 2007 - 2011
Position:	Left
Notes:	Includes Bulbs; wo/Marker Light
OE Number:	3565429C91, 3565429C93, 3565429C92, 4020416C91

Headlight Bezel  **889-5101**



Make:	International Bus
Applications:	3800 CE, 4200, 4300, 4300LP, 4400, 4400LP, 4600, 4600LP, 4600UH, 4700, 4700LP, 4700LPX, 4800, 4900, 8000, 8100, 8200, 8300, 8500, 8500 SBA, 8600 SBA 1990 - 2004
Position:	Left
Notes:	Gray
OE Number:	EE02004024, 1661763C1, 1654293C1, 3000077C1, 34004277

SCHOOL BUS, INTERNATIONAL

Headlight Bezel – Washer Fluid Reservoir

Headlight Bezel  **889-5102**





Make:	International Bus
Applications:	3800 CE, 4200, 4300, 4300LP, 4400, 4400LP, 4600, 4600LP, 4600UH, 4700, 4700LP, 4700LPX, 4800, 4900, 8000, 8100, 8200, 8300, 8500, 8500 SBA, 8600 SBA 1990 - 2004
Position:	Right
Notes:	Gray
OE Number:	1654294C1, 1661764C1, 3000078C1, EE02004023, 34004274

Hood Hinge Spring  **938-5101**



Make:	International Bus
Applications:	3000, 3600, 3700, 3800, 3800 CE, 3900FC, 4600, 4600LP, 4600UH, 4700, 4700LP, 4700LPX, 4800, 4900, S1654, S1654LP, S1753, S1754, S1800, S1853, S1853FC, S1854, S1954, S1955, S2155, S2554 1989 - 2001
Position:	
Notes:	Gold
OE Number:	1675762C3

Hood Latch Assembly  **315-5101**





Make:	International Bus
Applications:	1452SC, 1552SC, 1652SC, 1652UP5, 4600, 4600LP, 4600UH, 4700, 4700LP, 4700LPX, 4800, 4900, 7100, 8000, 8500 TranStar, 8600 TranStar, M1400 Metro II, M1600 Metro II, S1654, S1654LP, S1723, S1724, S1753, S1754, S1800, S1823, S1824, S1853, S1853FC, S1854, S1 1980 - 2011
Position:	Left; Right
Notes:	Contains all brackets
OE Number:	500273C2, 500271C1, 499523C3, 500274C1, 500269C1, 1689930C91, 500269A, 1699930C92, 1699929C91, 500270C1, 500273C1, 1699929C9, 1689930C9

HVAC Heater Water Shut-Off Valve Actuator  **604-5103**



Make:	International Bus
Applications:	1988 - 2015
Position:	
Notes:	4 Pin Connector; Label ID No. A35130293B
OE Number:	ZGG717058, 2118004, H9635, 101432, 651258, MA1430, 2371, 2380, MA1360, 2370, 650341BSM, 101032, ZGG717002, 3543H9635, 868505BSM, 1696831C1, ABPN833280, 2499080, 2392, ABPN833241, 2117005, 324165BSM, 71R3571, 3020965, MA020001S, 3947439, 00031247,

Instrument Panel Circuit Board  **599-5103**





Make:	International Bus
Applications:	2554, 2574, 2654, 2674, 3000, 3000 IC, 3000FE, 3000IC, 3000RE, 3400, 3600, 3700, 3800, 3800 CE, 3900, 3900FC, 4700, 4700LP, 4700LPX, 4800, 4900, 8100 1992 - 2002
Position:	
Notes:	New not remanufactured, fits both electric and mechanical oil pressure gauges
OE Number:	3595124C2, 3525091C91, 3525074C91, 3595124C1, 1689995C93, 1689996C93, 3525078C91, 2512565C91

Manifold Absolute Pressure Sensor  **904-7505**



Make:	International Bus
Applications:	International VT365, DT530, T444E 1979 - 2016
Position:	Manifold
Notes:	
OE Number:	1840078C1

Manifold Absolute Pressure Sensor  **904-7525**



Make:	International Bus
Applications:	International VT365, DT466, DT530 1979 - 2016
Position:	Manifold
Notes:	
OE Number:	1839416C91

Manifold Absolute Pressure Sensor  **904-7532**





Make:	International Bus
Applications:	International VT365 1986 - 2016
Position:	Manifold
Notes:	
OE Number:	1846481C92

Multi Function Switch  **978-5101**





Make:	International Bus
Applications:	3000, 3000RE, 3200, 3300, 3400, 3600, 3800, 3800 CE, 4700, 4700LP, 4700LPX, 4800, 4900 1989 - 2010
Position:	
Notes:	Thomas School Buses Built On International Chassis
OE Number:	1669742C91, 2502912C91, 1685611C91, 1699742C91

Roof Marker Light  **888-5125**



Make:	International Bus
Applications:	4200, 4200LP, 4300, 4300LP, 4400, 4400LP, 5600, 5600i, 5900, 5900i, 7300, 7300 SBA, 7300 SFA, 7400, 7500, 7600, 8600, 9200, 9200 SBA, 9200i SBA, 9400, 9400i SBA, 9800, 9800 SBA, 9800 SFA, 9900, 9900 SFA, 9900i, 9900i SFA, 9900ix, 9900ix SFA, BE, CE, Lonestar 1986 - 2016
Position:	
Notes:	Amber
OE Number:	3529900C97

Turbocharger Speed Sensor  **904-7146**



Make:	International Bus
Applications:	ISB 200, ISB 6.7, ISB6.7, ISB6.7-200, ISB6.7-220, ISB6.7-240, ISB6.7-260, ISB6.7-280 2011 - 2016
Position:	
Notes:	
OE Number:	4032806

Washer Fluid Reservoir  **603-5102**



Make:	International Bus
Applications:	3000, 3000RE, 3200, 3300, 3400, 3600, 3800, 3800 CE, 4900 1997 - 2007
Position:	
Notes:	Includes caps, pump, and level sensors (where applicable)
OE Number:	2033902C92, 2033902C91, 2033903C92

SCHOOL BUS, INTERNATIONAL

Windshield Washer Nozzle

Windshield Washer Nozzle 

924-5101 



Make:	International Bus
Applications:	3000, 3000RE, 3200, 3300, 3300 CE, 3400, 3600, 3800, 3800 CE, 4100, 4200, 4200LP, 4300, 4300LP, 4400, 4400LP, 4700, 4700LP, 4700LPX, 4800, 4900, 2001 - 2015
Position:	Front
Notes:	Includes washer hose and nozzle
OE Number:	1696499C1

NEED HELP FINDING AN ABS SENSOR?

DORMAN HD SOLUTIONS HAS YOU COVERED.

SEARCH PRODUCTS

Year/Make/Model

Keyword, Phrase or Part Number

Interchange # or VMRS Code

Looking for an ABS Sensor?

- Select the **SENSOR STYLE** you are looking for.
- Choose the **SENSOR LENGTH (in.)**.
- Pick the **CONNECTOR TYPE** for your ABS Sensor

Additional Resources

[ABS Sensor Poster](#)

[How to Measure Sensor Length](#)

Select Sensor Style

All



Straight Sensor
Select Sensor Lengths
2.27 in



Straight with Flange Sensor
Select Sensor Lengths
0.71 in



Right Angle Sensor
Select Sensor Lengths
1.57 in



Right Angle-Jacketed Sensor
Select Sensor Lengths
1.62 in

Select Sensor Length (in.)

All

0.71

1.57

1.62

2.27

Select Connector Type

All



ABS Sensors

ABS SENSOR SELECTION TOOL

Find the right ABS sensor in 3 easy clicks!
Visit www.DormanHDSolutions.com/abssensors



Growing the size of the
HEAVY DUTY
A f t e r m a r k e t

ABS SENSORS

ABS Control Modules	104
ABS Speed Sensors	104
ABS Speed Sensor Brackets	108
ABS Speed Sensor Wiring Harnesses...	109

ABS SENSORS

ABS Control Module - Remanufactured – ABS Wheel Speed Sensor

ABS Control Module - Remanufactured 599-7001



Make: Meritor, Rockwell, Wabco
OE Number: S4001082010, S4005001010, S4721950330

ABS Control Module - Remanufactured 599-7002



Make: Meritor, Rockwell, Wabco
OE Number: S4005001030, S4008506010, S4008506020

ABS Wheel Speed Sensor 970-5001



Make: Haldex, Midland, Hino, Meritor, Wabco
Sensor Type: Right Angle
Cable Length: 79 in. (200.7 cm)
Connector Type: Round 2 Pin
OE Number: R955342, S4410328140, 2504131C1, 894417810A

ABS Wheel Speed Sensor 970-5002



Make: Meritor, Rockwell, Wabco
Sensor Type: Straight
Cable Length: 69 in. (175.3 cm)
Connector Type: Round 2 Pin
OE Number: R955338

ABS Wheel Speed Sensor 970-5003



Make: Meritor, Rockwell, Wabco, Hino, Ford
Sensor Type: Right Angle
Cable Length: 67 in. (170.2 cm)
Connector Type: Round 2 Pin
OE Number: R955341, S4410328130, 894417830A, 3526132C1

ABS Wheel Speed Sensor 970-5004



Make: Meritor, Rockwell, Wabco
Sensor Type: Right Angle
Cable Length: 69 in. (175.3 cm)
Connector Type: Round 2 Pin
OE Number: R955328, S4410321030

ABS Wheel Speed Sensor 970-5005



Make: Meritor, Rockwell, Wabco
Sensor Type: Straight
Cable Length: 69 in. (175.5 cm)
Connector Type: Round 2 Pin
OE Number: R955329, S4410329190

ABS Wheel Speed Sensor 970-5006



Make: Meritor, Rockwell, Wabco, Workhorse
Sensor Type: Right Angle
Cable Length: 39 in. (99.1 cm)
Connector Type: Round 2 Pin
OE Number: R955336, S4410328090, W8001709

ABS Wheel Speed Sensor 970-5007



Make: Chevrolet, GMC
Applications: C60 Kodiak, C6000 Topkick, C6500 Kodiak, C6500 Topkick, C70 Kodiak, C7000 Topkick, C7500 Kodiak, C7500 Topkick 1995 - 2002
Position: Front Left; Front Right; Rear Left; Rear Right
Notes: School Bus
Sensor Type: Right Angle
Cable Length: 85 in. (195.6 cm)
Connector Type: Metripack GT 150 (Packard)
OE Number: 89026854, 15737201

ABS SENSORS

ABS Wheel Speed Sensor – ABS Wheel Speed Sensor

ABS Wheel Speed Sensor **970-5008**



Make:	Meritor, Rockwell, Wabco
Sensor Type:	Right Angle
Cable Length:	15 in. (38.8 cm)
Connector Type:	Round 2 Pin
OE Number:	R955355, S4410328080

ABS Wheel Speed Sensor **970-5010**



Make:	Bendix
Sensor Type:	Right Angle
Cable Length:	76 in. (193 cm)
Connector Type:	Round 2 Pin
OE Number:	65703, 300084, 300084N, 5001064, 5009349, 550387, 800110, 801538, BW5001064, BW550387, BW801538, 745-300084, 745801538, BAN801538, BX800110, BX801538, ZAC300084, ZAC800110, ZAC801538, 801538BXW, BW801538, BW801538

ABS Wheel Speed Sensor **970-5011**



Make:	Bendix
Sensor Type:	Straight
Cable Length:	79 in. (200.7 cm)
Connector Type:	Round 2 Pin
OE Number:	300087, 300087N, 801542, BW801542, 745801542, BAN801542, BX801542, ZAC300087, ZAC801542, BW801542, BW801542

ABS Wheel Speed Sensor **970-5012**



Make:	Bendix
Sensor Type:	Straight
Cable Length:	66 in. (167.6 cm)
Connector Type:	Round 2 Pin
OE Number:	65640, 065711, 300151, 300151N, 300171, 5001066, 5006809, 5010110, 550759, 550796, 65640, 800111, 801543, BW065711, BW300171, BW5001066, BW801543, 745-065640, 745801543, BAN801543, BX800111, BX801543, ZAC065640, ZAC065711, ZAC300151, ZAC801543, 801543BXW, BW801543, 3933880, 85108686, BW065640, BW801543

ABS Wheel Speed Sensor **970-5013**



Make:	Meritor, Rockwell, Wabco
Sensor Type:	Right Angle
Cable Length:	79 in. (199.7 cm)
Connector Type:	Round 2 Pin
OE Number:	TDAS4410321840, S4410321840

ABS Wheel Speed Sensor **970-5014**



Make:	Meritor, Rockwell, Wabco
Sensor Type:	Right Angle
Cable Length:	67 in. (169.7 cm)
Connector Type:	Round 2 Pin
OE Number:	TDAS4410321850, S4410321850

ABS Wheel Speed Sensor **970-5015**



Make:	Isuzu
Sensor Type:	Straight with flange
Cable Length:	14 in. (35 cm)
Connector Type:	2 Pin - Isuzu
OE Number:	8973312182

ABS Wheel Speed Sensor **970-5016**



Make:	Workhorse
Sensor Type:	Right Angle
Cable Length:	39 in. (99.6 cm)
Connector Type:	Round 2 Pin
OE Number:	W8001709

ABS Wheel Speed Sensor **970-5023**



Make:	Meritor, Rockwell, Wabco
Sensor Type:	Straight
Cable Length:	67 in. (170.2 cm)
Connector Type:	Round 2 Pin
OE Number:	TDAR955337, 8235-R955337, R955337, TDAR955337

ABS SENSORS

ABS Wheel Speed Sensor – ABS Wheel Speed Sensor

ABS Wheel Speed Sensor		970-5100
		
Make:	Universal	
Sensor Type:	Right Angle	
Cable Length:	24 in. (61 cm)	
Connector Type:	Round 2 Pin	
OE Number:		

ABS Wheel Speed Sensor		970-5102
		
Make:	Haldex, Midland	
Sensor Type:	Right Angle	
Cable Length:	20 in. (50 cm)	
Connector Type:	Round 2 Pin	
OE Number:	HDXAL10271914, 102719AA, 102719AD, 364094001, AL10271914, SN154BC, 5396-AL10271914, ZZAL10271914, HDXAL10271914, MIDAL10271914	

ABS Wheel Speed Sensor		970-5104
		
Make:	Bendix, Ford, Thomas	
Sensor Type:	Right Angle	
Cable Length:	63 in. (160 cm)	
Connector Type:	Deutsch DTM06	
OE Number:	5000889, 5001167, 5001327, 5003608, 5005707, 5006828, 5011723, 800132, 800199, 800344, 800593, 800655, 801396, 801546, F8HT-2B372-BA, BW800199, BW801546, F8HT-2B372-BA, 745-801546, BAN801546, BX801546, ZAC801546, BW801546, F8HT-2B372-BA, 61201160, BW801546	

ABS Wheel Speed Sensor		970-5107
		
Make:	Bendix	
Sensor Type:	Straight	
Cable Length:	78 in. (198.1 cm)	
Connector Type:	Deutsch DT04	
OE Number:	65310, 065414, 065502, 5001663, 5007842, 5007844, 5012269, 550341, 550534, 550686, 800791, 800793, 801552, 5C4Z-2C204-DA, F4HT-2B372-AA, F4HZ-2B372-A, BW065414, BW065502, BW801552, 745-801552, 1684327C92, 1684327C93, 3591876C91, BAN801552, BX065502, BX801552, ZAC065310, ZAC065414, ZAC065502, ZAC800791, ZAC800793, ZAC801552, BW065414, BW801552	

ABS Wheel Speed Sensor		970-5108
		
Make:	Bendix, Ford	
Sensor Type:	Right Angle - Jacketed	
Cable Length:	43 in. (109 cm)	
Connector Type:	Deutsch DT04	
OE Number:	800717, 4C4Z-2C190-AA, 5C4Z-2C204-FA, BW800717, 745-800717, 2589756C91, 3539548C92, BAN800717, BX800717, ZAC800717, BW800717, BW800717	

ABS Wheel Speed Sensor		970-5109
		
Make:	Bendix	
Sensor Type:	Right Angle	
Cable Length:	15 in. (38.1 cm)	
Connector Type:	Round 2 Pin	
OE Number:	300083, 300083N, 5008455, 801544, BW801544, 745-801544, BAN801544, BX801544, ZAC801544, BW801544, BW300083, BW801544	

ABS Wheel Speed Sensor		970-5110
		
Make:	Bendix	
Sensor Type:	Straight	
Cable Length:	43 in. (109.2 cm)	
Connector Type:	Deutsch DT04	
OE Number:	5010403, 5012270, 801175, 801553, 5C4Z-2C204-CA, BW801175, BW801553, 745-801553, 3571899C91, 3591875C91, BAN801553, BX801553, ZAC801175, ZAC801553, BW801553, BW801553	

ABS Wheel Speed Sensor		970-5113
		
Make:	Universal	
Sensor Type:	Straight	
Cable Length:	17 in. (43.2 cm)	
Connector Type:	Round 2 Pin	
OE Number:		

ABS Wheel Speed Sensor		970-5115
		
Make:	Bendix	
Sensor Type:	Right Angle	
Cable Length:	78 in. (198.1 cm)	
Connector Type:	Deutsch DT04	
OE Number:	65280, 065324, 5007339, 5012267, 550385, 800716, 801550, 5C4Z-2C204-BA, BW065324, BW801550, 745-801550, 1686805C91, 3591874C91, BAN801550, BX065324, BX801550, ZAC065324, ZAC800716, ZAC801550, BW065324, BW801550, BW801550	

ABS SENSORS

ABS Wheel Speed Sensor – ABS Wheel Speed Sensor

ABS Wheel Speed Sensor **970-5116**



Make:	Bendix, Ford
Sensor Type:	Right Angle
Cable Length:	43 in. (109.2 cm)
Connector Type:	Deutsch DT04
OE Number:	65528, 5000530, 5012268, 550715, 800055, 801551

ABS Wheel Speed Sensor **970-5117**



Make:	Bendix, Ford
Sensor Type:	Right Angle
Cable Length:	63 in. (160 cm)
Connector Type:	Deutsch DT04
OE Number:	65301, 65323, 5012266, 550335, 550384, 550442, 800715, 801549, F3HT-2B372-AA, F3HZ-2B372-A, BW065301, BW800715, BW801549, 745-800715, 745-801549, 800715, A3237W1063, 1684328C91, 1684328C92, 1684328C93, 2589757C91, 3591873C91, BAN800715, BAN801549, BX065368, BX800715BX801549, ZAC065301, ZAC065368ZAC800715, BW801549

ABS Wheel Speed Sensor **970-5118**



Make:	Meritor, Rockwell, Wabco
Sensor Type:	Straight
Cable Length:	81 in. (205.7 cm)
Connector Type:	Round 2 Pin
OE Number:	TDAR955349, 8235-R955349, 4410329710, R955349, TDAR955349

ABS Wheel Speed Sensor **970-5120**



Make:	Bendix, Ford, Thomas
Sensor Type:	Straight
Cable Length:	63 in. (160 cm)
Connector Type:	Deutsch DTM06
OE Number:	5001325, 5001694, 5003067, 5004084, 5005223, 5005225, 5005706, 5006177, 5012846, 800160, 800197, 800306, 800343, 800542, 800544, 800592, 800614, 801563, 974013, 974013, F8HT-2B372-FA, F8HZ-2B372-FA, BW801563, 745-801563, BAN801563, BX800197ZAC800197, ZAC801563, ZBP0974013BW801563

ABS Wheel Speed Sensor **970-5123**



Make:	Universal
Sensor Type:	Right Angle
Cable Length:	39 in. (99 cm)
Connector Type:	Round 2 Pin

ABS Wheel Speed Sensor **970-5126**



Make:	Bendix, Ford
Sensor Type:	Right Angle
Cable Length:	50 in. (127 cm)
Connector Type:	Deutsch DTM06
OE Number:	5000890, 5001326, 5001328, 5001667, 5001695, 5004459, 5004602, 5011725, 800161, 800198, 800200, 800356, 800442, 800489, 800690, 801398, 801548, F8HT-2B372-EA, F8HZ-2B372-DA, F8HZ-2B372-EA, BW800198, BW800200, BW801548, 745-801548, 2589857C91, BAN801548BX800198, BX801548, ZAC800198ZAC800690

ABS Wheel Speed Sensor **970-5130**



Make:	Haldex, Midland
Sensor Type:	Right Angle
Cable Length:	98 in. (248.9 cm)
Connector Type:	Round 2 Pin
OE Number:	HDXAL364062, 364094081, AL364062, 5396-AL364062, ZZAL364062, HDXAL364062, MIDAL364062

ABS Wheel Speed Sensor **970-5134**



Make:	Haldex, Midland
Sensor Type:	Straight
Cable Length:	79 in. (200.7 cm)
Connector Type:	Round 2 Pin
OE Number:	HDXAL1027195, HDXAL1027197, 364528011, AL1027197, 5396-AL1027197, HDXAL1027195, HDXAL1027197, MIDAL1027197

ABS Wheel Speed Sensor **970-5135**



Make:	Bendix
Sensor Type:	Right Angle
Cable Length:	66 in. (167.6 cm)
Connector Type:	Round 2 Pin
OE Number:	65705, 300150, 300150N, 5001063, 5003100, 5006810, 550532, 65705, 800109, 800308, 800813, 801541, BW5001063, BW550532, BW801541, 745-801541, BAN801541, BX801541, ZAC300150, ZAC550532, ZAC800109, ZAC801541, BW801541, 3949775, 8083194, BW801541

ABS SENSORS

ABS Wheel Speed Sensor – ABS Wheel Speed Sensor Bracket

ABS Wheel Speed Sensor		970-5136
		
Make:	Haldex, Midland	
Sensor Type:	Straight	
Cable Length:	20 in. (50.8 cm)	
Connector Type:	Round 2 Pin	
OE Number:	HDXAL1027196, 364528001, AL1027196, 5396-AL1027196, HDXAL1027196, MIDAL1027196	

ABS Wheel Speed Sensor		970-5601
		
Make:	Chevrolet, GMC	
Applications:	C5500 Kodiak, C5500 Topkick, C6500 Kodiak, C6500 Topkick, C7500 Kodiak, C7500 Topkick, C8500, C8500 Kodiak, C8500 Topkick, T6500, T7500, T8500 2003 - 2009	
Position:	Front, Rear	
Notes:	Air Brakes (JE4), Hydraulic Brakes (JE3), Hydraulic Brakes; H08, HD1 or HPK Rear Axle Codes	
Sensor Type:	Straight	
Cable Length:	53 in. (134.6 cm)	
Connector Type:	Metripack GT 150 (Packard)	
OE Number:	20784542, 15108411, 15108407, 89026858	

ABS Wheel Speed Sensor		970-5602
		
Make:	Chevrolet, GMC	
Applications:	B7, C60 Kodiak, C6000 Topkick, C6500 Kodiak, C6500 Topkick, C70 Kodiak, C7000 Topkick, C7500 Kodiak, C7500 Topkick, T6500, T7500 1995 - 2002	
Position:	Front Left; Front Right, Rear Left; Rear Right	
Notes:	90 Degree Bend Sensor, Exc. School Bus	
Sensor Type:	Right Angle	
Cable Length:	77 in. (195.6 cm)	
Connector Type:	Metripack GT 150 (Packard)	
OE Number:	89026854	

ABS Wheel Speed Sensor		970-5603
		
Make:	Chevrolet, GMC	
Applications:	C4500 Kodiak, C4500 Topkick, C5500 Kodiak, C5500 Topkick 2003 - 2009	
Position:	Front Left; Front Right	
Notes:	6,000 Lb. to 6,250 Lb. Front Axle (FK7, FN9 or FR5); 7,000 Lb. Front Axle (FK6 or FM7); 6,250 Lb. Front Axle (FR5); 7,000 Lb. Front Axle (FM7); 7,000 Lb. Front Axle (FM7)	
Sensor Type:	Straight	
Cable Length:	36 in. (91.4 cm)	
Connector Type:	Metripack GT 150 (Packard)	
OE Number:	15033710	

ABS Wheel Speed Sensor Bracket		924-5209
		
Make:	Ford, Freightliner, Sterling, Universal	
Applications:	Columbia, Columbia 112, Columbia 120, FLD 112, FLD 120, FLD 132, FLD120 SD 1996 - 2005	
OE Number:	4C4Z-2A155-AA	

ABS Wheel Speed Sensor Bracket		970-5103
		
Make:	Bendix, Haldex, Midland	
OE Number:	HDXAL920809, 100469H, AL920809, 5396-AL920809, TEC94050, ZZAL920809, HDXAL920809, MIDAL920809	

ABS Wheel Speed Sensor Bracket		970-5121
		
Make:	Haldex, Midland	
OE Number:	5396-AL920810, TEC94049, ZZAL920810, MIDAL920810	

ABS Wheel Speed Sensor Bracket		970-5124
		
Make:	Haldex, Midland	
OE Number:	HDXA902700, 102700C, A902700, 5396-A902700, ZZA902700, HDXA902700, MIDA902700	

ABS Wheel Speed Sensor Bracket		970-5128
		
Make:	Haldex, Midland	
OE Number:	100469F, A902701, 5396-A902701, ZZA902701, HDXA902701, MIDA902701	

ABS SENSORS

ABS Wheel Speed Sensor Bracket – ABS Wheel Speed Sensor Wiring Harness

ABS Wheel Speed Sensor Bracket 970-5129



Make: Haldex, Midland
OE Number: ZZ102008WN, ZZA920802, HDXA920802, MIDA920802, HDXA920802, 102008WN, A920802, 5396A920802

ABS Wheel Speed Sensor Bracket 970-5132



Make: Haldex, Midland
OE Number: 59512309, A059512309, A59512309, A059512309, 5396-A59512309, ZZ059512309, ZZA59512309, HDXA59512309, MIDA59512309

ABS Wheel Speed Sensor Bracket 970-5600



Make: Chevrolet, GMC
Applications: C4500 Kodiak, C5000 Topkick, C5500 Kodiak, C60 Kodiak, C6000 Topkick, C6500 Kodiak, C6500 Topkick, C70 Kodiak, C7000 Topkick, C7500 Kodiak, C7500 Topkick 1990 - 2002
Notes: ABS Retainer
OE Number: 15108406, 15960699

ABS Wheel Speed Sensor Wiring Harness 970-5101



Make: Meritor, Rockwell, Wabco
Cable Length: 120 in. (304.8 cm)
Connector Type: Round 2 Pin
OE Number: TDAS4497130300, 8235-S4497130300, 4497130300, 8945900692, S4497130300, ATIS4497130300, S4497130300, S4497130300, TDAS4497130300

ABS Wheel Speed Sensor Wiring Harness 970-5106



Make: Haldex, Midland
Cable Length: 79 in. (200.7 cm)
Connector Type: Round 2 Pin
OE Number: HDXAL919803, 201198BD, AL919803, 5396-AL919803, ZZ201198BD, ZZAL919803, HDXAL919803, MIDAL919803

ABS Wheel Speed Sensor Wiring Harness 970-5119

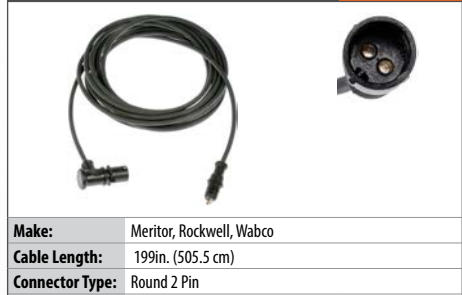

Make: Meritor, Rockwell, Wabco
Cable Length: 199in. (505.5 cm)
Connector Type: Round 2 Pin
OE Number: 8235-S4497130500, 4497130500, 8945900702, S4497130500, ATIS4497130500, S4497130500, TDAS4497130500, TDAS4497130500,

ABS Wheel Speed Sensor Wiring Harness 970-5125

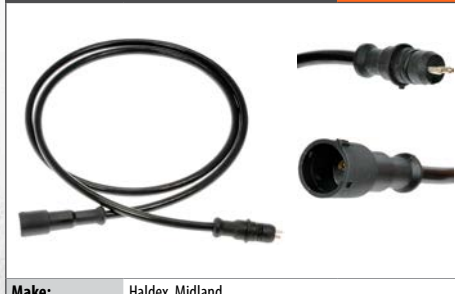

Make: Haldex, Midland
Cable Length: 40 in. (101.6 cm)
Connector Type: Round Pin 2
OE Number: HDXAL919801, 201198BB, AL919801, 5396-AL919801, ZZAL919801, HDXAL919801, MIDAL919801

ABS Wheel Speed Sensor Wiring Harness 970-5127

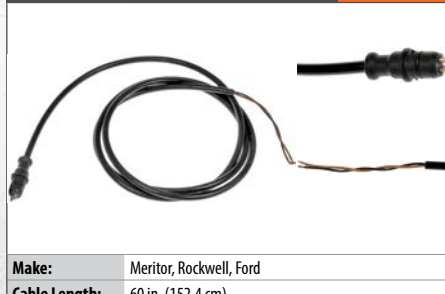

Make: Meritor, Rockwell, Ford
Cable Length: 60 in. (152.4 cm)
Connector Type: Round 2 Pin
OE Number: 4C40-9D878-CA, 4C4Z-9D878-CA, TDAS4497110150, WAB4497110150, 8235-S4497110150, 4497110150, S4497110150, 3519878C1, ATIS4497110150, S4497110150, S4497110150, TDAS4497110150, WAB4497110150, TDAS4497110150

ABS Wheel Speed Sensor Wiring Harness 970-5131

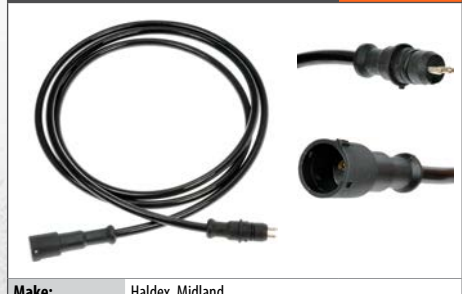

Make: Haldex, Midland
Cable Length: 60 in. (152.4 cm)
Connector Type: Round 2 Pin
OE Number: HDXAL919802, 201198BC, AL919802, 5396-AL919802, ZZ201198BC, ZZAL919802, MIDAL919802

ABS SENSORS

ABS Wheel Speed Sensor Wiring Harness

ABS Wheel Speed Sensor Wiring Harness		970-5133
		
Make:	Haldex, Midland	
Cable Length:	99 in. (251.5 cm)	
Connector Type:	Round 2 Pin	
OE Number:	HDXAL919804, 201198BE, AL919804, 5396-AL919804, MIDAL919804, ZZAL919804, MIDAL919804	

ABS SENSORS
HOW TO MEASURE THE LENGTH

SENSOR LENGTH

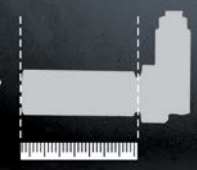

CABLE LENGTH*



*Cable Length: Measurement starts from the connector (B) to the point where the wire meets the sensor housing (A). The measurement does not include the sensor's total length.

NEED HELP FINDING AN ABS SENSOR?

DORMAN HD SOLUTIONS HAS YOU COVERED.

SEARCH PRODUCTS

Looking for an ABS Sensor?

- Select the **SENSOR STYLE** you are looking for.
- Choose the **SENSOR LENGTH (in.)**
- Pick the **CONNECTOR TYPE** for your ABS Sensor

Additional Resources

ABS Sensor Poster
How to Measure Sensor Length

Select Sensor Style

All



Straight Sensor
Select Sensor Lengths 2.27 in



Straight with Flange Sensor
Select Sensor Lengths 0.71 in



Right Angle Sensor
Select Sensor Lengths 1.57 in



Right Angle-Jacketed Sensor
Select Sensor Lengths 1.62 in

Select Sensor Length (in.)

All

0.71



1.57



1.62



2.27



Select Connector Type



All

ABS Sensors

ABS SENSOR SELECTION TOOL

Find the right ABS sensor in 3 easy clicks!
 Visit www.DormanHDSolutions.com/abssensors



Growing the size of the
HEAVY DUTY
A f t e r m a r k e t

PART INDEX SEARCH

PART NUMBER INDEX

090-5001 – 641-5017

090-5001	8,22,34,54,74	242-5502	46,93	455-5002	90	603-5103	21
090-5002	9,22,35,44, 54,61,67,74,87	242-5503	43,92	455-5003	90	603-5104	21,99
090-5003	9,22,35,44, 54,67,74,87	242-5513	68	455-5004	90	603-5107	21
090-5004	9,22,35,44, 54,62,67,74,89	242-5529	65	455-5005	90	603-5110	21,99
095-5001	9,22,35,54,74	242-5530	65	455-5007	90	603-5201	7,97
095-5002	9,22,35,44, 54,62,67,74,87	242-5601	78	455-5008	90	603-5202	7,97
095-5003	9,22,35,44, 54,67,74,87	285-5101	24	455-5009	90	603-5203	7
157-5101	29	285-5103	24	455-5010	90	603-5204	17
157-5102	29	285-5104	24,100	505-5101	21,99	603-5207	7,97
157-5103	29	285-5105	24,100	505-5104	30	603-5209	7
157-5104	29	285-5110	24	505-5105	30	603-5214	17
157-5106	29	285-5203	11	505-5110	20	603-5401	41
157-5111	29	285-5207	11,97	505-5201	17,94	603-5402	41,59
157-5201	16	285-5401	56	505-5203	8	603-5403	34,53
157-5202	16	285-5402	56	505-5401	32,52	603-5404	59
157-5203	16	285-5403	56	505-5406	41,59	603-5501	43
157-5402	40	285-5404	36	505-5407	59	603-5502	44
157-5403	40,59	285-5405	36	505-5408	59	603-5503	50,94
157-5501	70	285-5406	37	505-5501	49	603-5504	66
157-5502	70	285-5501	45	505-5504	49,93	603-5505	44,66
157-5503	70	285-5503	46,92	505-5505	50,94	603-5506	71
157-5504	70	285-5504	46	505-5506	49	603-5508	71
157-5505	70	285-5505	46	505-5507	50,94	603-5510	66
157-5506	71	285-5506	46	505-5510	71	603-5512	50,94
157-5507	49,93	285-5507	46	505-5511	70	603-5601	79
157-5508	49,94	285-5508	46,93	505-5512	50,94	603-5602	81
157-5509	49,94	285-5509	68	578-5102	24,100	603-5603	79
157-5510	49,94	300-5600	81	578-5201	11,97	603-5604	79
216-5101	19	315-5101	26,101	578-5401	37	603-5751	82
216-5202	4	315-5201	13	578-5402	37	603-5752	82
216-5203	4	315-5202	13	578-5403	37	604-5101	26
216-5401	32	315-5203	13	578-5404	37	604-5103	26,38,57, 69,75,101
216-5402	32	315-5204	13	578-5405	37	604-5104	26,47
216-5403	32	315-5205	13	578-5406	56	604-5105	26
216-5406	32	315-5206	13	578-5407	56	604-5106	26,38
216-5407	52	315-5207	13	594-5600	80	604-5107	26
216-5408	52	315-5401	38	599-5001	17	604-5112	38
216-5409	52	315-5402	38	599-5001	29,40,49,59, 71,76,88	604-5113	57
216-5901	73	315-5501	69	599-5002	71	604-5120	14
242-5106	19	315-5502	47,93	599-5103	26,101	604-5131	69
242-5107	24,100	315-5503	47,93	599-7001	104	604-5155	47
242-5201	11	315-5507	69	599-7002	104	604-5401	38
242-5202	11	315-5520	49	602-5403	41	604-5402	57
242-5204	4	315-5520	93	602-5404	41	620-5601	79
242-5205	4	341-5001	16,63,76,89	602-5405	42	641-5101	28
242-5208	11,98	341-5010	17	602-5411	60	641-5102	28
		419-5000	79	602-5601	81	641-5104	28
		419-5002	79	603-5101	21,99	641-5106	28
		419-5005	79	603-5102	30,101	641-5107	29
		455-5001	90				

PART NUMBER INDEX

641-5109 – 888-5405

641-5109	29	750-5501	50,94	760-5501	45,92	775-5501	50,94
674-5002	10,23,36,55, 62,75,84	750-5502	50,94	760-5502	45	775-5502	50,95
674-5600	80	750-5503	50	760-5503	69	775-5503	72
674-5602	80	750-5504	50	760-5504	69	775-5504	72
674-5603	80	750-5505	50	760-5509	68	775-5505	72
674-9000	4,19,32,43, 52,65,73,86	750-5506	65	760-5510	68	775-5506	72
699-5501	43,92	750-5507	65	760-5512	45	775-5600	81
702-5401	57	750-5508	65	760-5516	45	775-5601	81
702-5402	38	750-5509	65	760-5523	45	775-5602	81
702-5501	70	760-5101	23	760-5601	80	775-5603	81
740-5103	31	760-5105	23	760-5602	80	775-5604	60
740-5104	31	760-5106	23	760-5603	80	800-5600	78
740-5501	51,95	760-5107	24	760-5604	80	800-5601	78
740-5502	51,95	760-5108	24	760-5605	80	800-5601	78
740-5503	51,95	760-5109	27	760-5606	80	800-5602	80
740-5504	51,95	760-5110	24	760-5607	80	800-5603	78
740-5505	51,95	760-5201	10	760-5608	81	800-5604	78
740-5506	51,95	760-5202	10	760-5750	82	888-5101	25
740-5507	51	760-5203	10,92	761-5103	27	888-5102	25
740-5508	51	760-5204	10,92	761-5104	27	888-5103	25
740-5509	72	760-5205	10	761-5105	27	888-5104	25
740-5510	72	760-5206	10	761-5106	27	888-5105	25
741-5101	28	760-5207	10	761-5107	27	888-5106	25
741-5102	28	760-5208	10	761-5108	27	888-5107	25
741-5201	16	760-5209	10	761-5109	27	888-5108	25
741-5202	16	760-5210	10	761-5201	14	888-5109	25,100
741-5203	16	760-5211	45	761-5202	15	888-5110	25,100
741-5204	16	760-5212	45	761-5204	15	888-5112	30
741-5401	58	760-5213	62	761-5205	15	888-5113	30
741-5402	58	760-5214	62	761-5215	15	888-5120	30
741-5403	39	760-5215	62	761-5216	15	888-5121	30
741-5404	39	760-5216	62	761-5406	39	888-5122	30
741-5405	39,58	760-5401	55	761-5407	39	888-5123	30
741-5406	40,58	760-5402	55	761-5503	48	888-5125	28,101
750-5102	19,99	760-5403	36	761-5505	48	888-5200	17
750-5103	19	760-5403	55	761-5506	48	888-5201	11
750-5104	19	760-5404	36	761-5507	45	888-5202	12
750-5203	5	760-5405	36	761-5509	48	888-5203	12,98
750-5206	5	760-5408	36,55	761-5510	48	888-5204	12,98
750-5207	5	760-5409	40	761-5513	71	888-5205	12
750-5208	5	760-5410	40	761-5514	71	888-5206	12
750-5209	5	760-5411	36	761-5600	81	888-5207	10
750-5211	5	760-5412	36	761-5601	81	888-5208	11
750-5213	5	760-5419	57	775-5101	30	888-5301	63
750-5214	5	760-5421	55	775-5102	31	888-5302	63
750-5215	5	760-5422	56	775-5104	31	888-5303	63
750-5401	41	760-5423	38	775-5201	18	888-5304	63
750-5402	41	760-5424	39	775-5202	18	888-5403	56
		760-5425	56	775-5203	64	888-5404	57
		760-5426	56	775-5402	41	888-5405	41

PART NUMBER INDEX

888-5406 – 924-5402

888-5406	58	901-5204	5	904-5502	65	904-7512	23,100
888-5411	59	901-5205	6	904-5601	79	904-7516	21,99
888-5414	36,56	901-5206	13	904-5602	79	904-7520	23
888-5420	41	901-5207	4	904-7012	9,22,35,55, 62,74,84	904-7522	23,100
888-5421	41	901-5401	33	904-7015	17,29,40,59, 63,76,85	904-7523	23,100
888-5422	40	902-0064	66	904-7016	9,23,35,55, 62,75,84	904-7525	28,101
888-5423	40	902-0065	67	904-7017	7,20,33,53, 61,73,84	904-7532	28,101
888-5501	46	902-5101	21,99	904-7018	11,24,36,56, 62,75,84	904-7629	41,59
888-5502	46	902-5102	21,99	904-7020	8,21,34,54, 61,74,84	904-7691	68
888-5503	46	902-5201	8,97	904-7021	8,21,34,54, 61,74,84	904-7705	44
888-5504	46	902-5202	8,97	904-7024	8,61,74,84	917-5101	22
888-5505	68	902-5204	8	904-7026	16,29,40,58, 63,76,85	917-5102	22
888-5506	68	902-5401	60	904-7027	9,23,35,55, 62,75,84	917-5201	8,89
888-5507	68	902-5402	53	904-7028	17,29,40,59, 64,76,85	917-5401	34
888-5508	69	902-5403	34,53	904-7029	11,24,36,56, 63,75,84	917-5501	67,87
888-5509	68	902-5404	18,54	904-7033	15,27,39,57, 63,75,84	917-5502	67,87
888-5510	68	902-5502	44	904-7037	15,27,39,58, 63,75,85	917-5503	67
888-5511	68	902-5504	67	904-7039	8,21,34,54, 61,73,84	917-5504	70
888-5512	68	902-5507	72	904-7107	15,27,39,48, 58,69,75,88	917-5505	44,92
888-5515	46	902-5601	79	904-7109	9,23,35,45, 55,62,72,75,87	917-5506	49
888-5516	49	904-5001	6,20,33,43, 53,66,73,86	904-7111	17,30,40,59, 71,76,88	917-5507	44,92
888-5517	71	904-5002	6,20,33,53, 61,66,73,87	904-7123	8,34,54, 61,87,97	917-5508	44,92
888-5518	71	904-5004	66	904-7124	15,39,58,63,88	917-5509	67
888-5527	70	904-5007	6,20,33,43, 52,66,73,86	904-7129	7,34,53,61,87	918-5601	78
888-5605	81	904-5008	6,20,33,52,86	904-7139	17,88	924-5101	31,102
888-5606	81	904-5009	6,33,53, 66,73,86	904-7142	15,48,63, 72,75,88	924-5103	19
888-5759	82	904-5010	6,20,53,86	904-7146	17,30,88	924-5104	25,100
888-5760	82	904-5011	20,53,86	904-7241	9,23,35,45, 55,72,75,88	924-5105	19
889-5101	25,100	904-5012	6,86,97	904-7247	8	924-5106	19
889-5102	26,101	904-5013	6,86,97	904-7254	17,64,76,89	924-5111	28
889-5201	12	904-5020	19,99	904-7441	71	924-5201	11
889-5202	12	904-5021	65	904-7505	27,101	924-5202	14
889-5203	12	904-5023	19,99			924-5203	14
889-5204	12	904-5035	6,20,33,43, 52,65,73,86			924-5204	4
889-5207	12	904-5036	6,20,33,52, 61,66,73,86			924-5205	7
889-5208	12	904-5050	9,22,35,45, 55,67,74,87			924-5206	14,98
889-5209	12	904-5052	6,61,86,97			924-5207	14,98
889-5210	13	904-5056	20,99			924-5209	4,108
889-5211	13	904-5062	20,99			924-5210	14
889-5212	13	904-5073	7,61,73			924-5212	11
889-5405	37	904-5101	22,100			924-5213	4
889-5406	37	904-5201	4,97			924-5215	4
889-5409	57	904-5401	32,52			924-5222	14
889-5410	57	904-5501	43,92			924-5223	14
889-5501	47					924-5224	18
889-5502	47					924-5225	18
889-5503	47,93					924-5226	18
901-0001	19					924-5229	15
901-0003	52					924-5401	52
901-5201	5					924-5402	57

PART NUMBER INDEX

924-5403 – 978-5514

924-5403	60	955-5403	32	970-5133	110
924-5405	39	955-5404	32	970-5134	107
924-5406	39	955-5405	32	970-5135	107
924-5410	38	955-5406	33	970-5136	108
924-5501	47,93	955-5407	33	970-5600	78,109
924-5502	47,93	955-5408	33	970-5601	78,108
924-5503	69	970-5001	104	970-5602	78,108
924-5504	72	970-5002	104	970-5603	78,108
924-5505	70	970-5003	104	978-5101	28,101
924-5506	43,92	970-5004	104	978-5102	28
924-5510	49,70	970-5005	104	978-5201	15,98
924-5514	65	970-5006	104	978-5204	16
924-5516	43	970-5007	78,104	978-5210	16,98
924-5519	70	970-5008	105	978-5211	16
924-5521	47	970-5010	105	978-5409	58
924-5528	43,65	970-5011	105	978-5411	58
924-5603	79	970-5012	105	978-5412	58
924-5604	79	970-5013	105	978-5501	69
936-5201	7,89	970-5014	105	978-5502	48,92
936-5202	7	970-5015	105	978-5503	48
936-5203	7	970-5016	105	978-5504	48
936-5401	53,87	970-5023	105	978-5505	48
936-5402	53	970-5100	106	978-5506	48
936-5403	34	970-5101	109	978-5511	69
936-5404	34	970-5102	106	978-5512	69
936-5405	34	970-5103	108	978-5514	73
936-5501	66	970-5104	106		
936-5502	66	970-5106	109		
936-5504	43	970-5107	106		
938-5101	26,101	970-5108	106		
938-5102	26	970-5109	106		
938-5103	26	970-5110	106		
938-5201	13,98	970-5113	106		
938-5401	37	970-5115	106		
938-5402	37	970-5116	107		
938-5403	37	970-5117	107		
938-5404	37	970-5118	107		
938-5405	38	970-5119	109		
938-5406	57	970-5120	107		
938-5407	57	970-5121	108		
938-5408	38	970-5123	107		
938-5501	47,93	970-5124	108		
938-5502	47,93	970-5125	109		
955-5201	4	970-5126	107		
955-5204	14	970-5127	109		
955-5205	14	970-5128	108		
955-5206	14	970-5129	109		
955-5208	5	970-5130	107		
955-5401	32	970-5131	109		
955-5402	32	970-5132	109		



Growing the size of the
HEAVY DUTY
Aftermarket

WE MAKE IT EASIER TO FIND PARTS

www.DormanHDSolutions.com

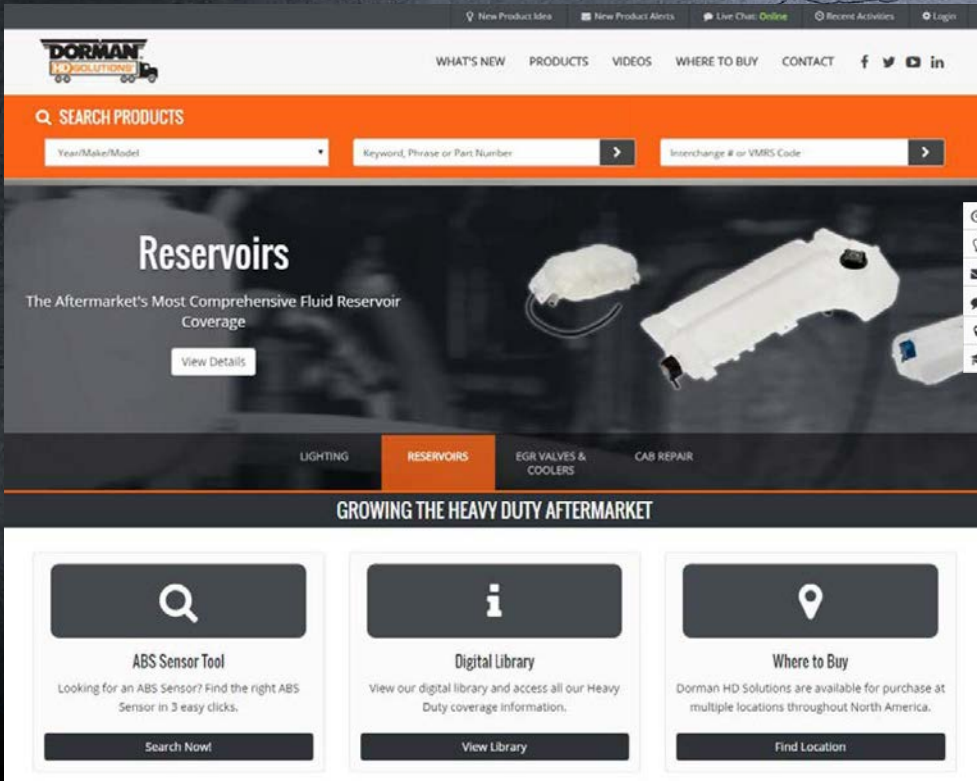

NEW AND IMPROVED WEBSITE

NEW PRODUCT IDEAS

- Always looking for the next New-to-the-Aftermarket product idea

LIVE TECH SUPPORT

- Available online, via phone or email

PRODUCT SEARCH

FIRST OF ITS KIND!

- Year/Make/Model Parts lookup
- Keyword, Phrase or Part Number
- Interchange Number or VMRS Code

PRODUCT INFORMATION

- ABS Sensor Search
- Make Specific Flyers
- Product Specific Flyers
- Where to Buy
- Product Videos

BE THE FIRST TO KNOW!
ABOUT FORMERLY "DEALER ONLY" PARTS

NEW FORMERLY "DEALER ONLY" PARTS ARE ADDED MONTHLY!



The Be-The-First-To-Know program keeps you updated with email and text announcements

SIGN UP TODAY!

DormanHDSolutions.com/btftk



HD76025-CAT2016

Dorman Products, Inc. | 3400 East Walnut Street | Colmar, PA 18915
Customer Service Line: 855-792-1183
HD Solutions Tech Line: 800-868-5777 x5501
©2016 No reproduction in whole or in part without prior written approval.

www.DormanHDSolutions.com